

# Wireless World

ELECTRONICS, RADIO, TELEVISION

Managing Editor: HUGH S. POCOCK, M.I.E.E.

Editor: H. F. SMITH

APRIL 1956

Assistant Editor: F. L. DEVEREUX, B.Sc.

## ***In This Issue***

Editorial Comment .. .. .	151
“Belt and Braces” Television Station .. .. .	152
World of Wireless .. .. .	154
Low-Distortion F.M. Discriminator .. .. .	<i>M. G. Scroggie</i> 158
Short-wave Conditions .. .. .	162
Television Society’s Exhibition .. .. .	163
Phase Shift and Sound Quality .. .. .	<i>J. Moir</i> 165
Books Received .. .. .	168
Television at U.H.F. .. .. .	169
Manufacturers’ Products .. .. .	170
Letters to the Editor .. .. .	171
More Lines for Colour? .. .. .	<i>V. J. Cooper</i> 173
Components Exhibition .. .. .	175
British Colour Television .. .. .	181
Sensitive Three-Valve T.R.F. Receiver (Modifications) <i>H. E. Styles</i> .. .. .	182
Experimental Colour Receiver—2 .. .. .	<i>H. A. Fairhurst</i> 183
Distortion—Audible and Visible .. .. .	“ <i>Cathode Ray</i> ” 188
V.H.F. at Sea .. .. .	<i>F. J. Wylie</i> 193
French Components Show .. .. .	195
Instructional Films on Waveguides .. .. .	196
April and May Meetings .. .. .	197
Random Radiations .. .. .	“ <i>Diallist</i> ” 198
Unbiased .. .. .	“ <i>Free Grid</i> ” 200

VOLUME 62 NO. 4

PRICE: TWO SHILLINGS

FORTY-SIXTH YEAR  
OF PUBLICATION

**PUBLISHED MONTHLY** (4th Tuesday of preceding month) by ILIFFE & SONS LTD., Dorset House, Stamford Street, London, S.E.1.  
**Telephone:** Waterloo 3333 (60 lines). **Telegrams:** “Ethaworld. Sedist. London.” **Annual Subscription:** Home and Overseas, £1 12s. 6d.  
U.S.A. and Canada \$5.00 **BRANCH OFFICES:** **BIRMINGHAM:** King Edward House, New Street, 2 **Telephone:** Midland 7191.  
**COVENTRY:** 8-10, Corporation Street. **Telephone:** Coventry 5210. **GLASGOW:** 26B, Renfield Street, C.2. **Telephone:** Central 1265.  
**MANCHESTER:** 260, Deansgate, 3. **Telephone:** Blackfriars 4412. **OVERSEAS OFFICES:** **U.S.A.:** 111, Broadway, New York 6, N.Y. **Telephone:** Digby 9-1197. **CANADA:** 74, College Street, Toronto, 2, Ontario. **Telephone:** Walnut 4-5331.

# MULLARD MAINTENANCE MANUAL



## with supplementary data service

This new Mullard publication provides a quick reference for essential information on Mullard receiving valves and tubes. Data given include typical operating conditions, limiting values and base connections.

Free supplementary data sheets will be issued from time to time, until a new edition of the Manual is published, to enable copies to be kept up-to-date.

The Mullard Maintenance Manual is obtainable from radio dealers, who can also arrange for the supply of free supplementary data sheets. In case of difficulty, apply direct to Mullard Ltd., Valve Sales Department, Century House, Shaftesbury Avenue, London, W.C.2.

### CONTAINING

- ▶ *Comprehensive valve and tube replacement guide.*
- ▶ *Essential data with dynamic operating conditions of current and obsolete Mullard receiving valves and picture tubes.*

PRICE 10/6

# Mullard



MULLARD LTD., CENTURY HOUSE, SHAFTESBURY AVENUE, LONDON, W.C.2

MVM 346

## Why 625 Lines?

THERE seems to be a growing belief that colour television for this country should be based on the continental 625-line system rather than on our present standards. This idea was given public expression at the opening of the recent components exhibition, when Sir Robert Renwick, president of the Radio and Electronic Component Manufacturers' Federation, strongly criticized the B.B.C. for spending "vast sums of money" on the development of a colour television system on 405 lines. Sir Robert's advocacy of a 625-line system was based on his belief that "the B.B.C. are developing a system which can only be manufactured for the home market, thus making the cost of manufacturing [receiving] sets for export on 625 lines quite prohibitive." It should be added here that Sir Robert was voicing personal opinions not necessarily endorsed by the radio industry organizations.

*Wireless World* is not convinced that 625 lines offers any particular advantages—technical, economic or commercial—for colour television. Nobody yet *knows* whether the countries at present committed to that standard for monochrome pictures will ultimately adopt a colour system compatible with it. And, if they do so, a rich export market in receivers will *not* automatically be opened up: experience suggests that most countries sufficiently developed industrially to embark on any kind of television service are likely to be able to assemble their own receivers—perhaps, though, from imported components.

In spite of all that has been written on the subject in this journal and elsewhere there is still a tendency in some quarters to make a fetish of multiplicity of lines. Sometimes it is even thought that a lineage of 625 is, as a matter of simple arithmetic, bound to be about 50 per cent better than 405. So far as monochrome is concerned, this fallacy has been largely dispelled; in relation to colour, the argument is brought up to date in an article on p. 173. Our contributor confines himself mainly to the technical and economic aspects. Broadly speaking, he reaches the conclusion that, just as 625 lines offers no decisive advantages for monochrome, it is even less attractive, in relation to our present standards, for transmissions in colour.

After attending the demonstration of colour tele-

vision reported on p. 181 we reached the conclusion that lineage was relatively unimportant in comparison with the need for devising a basically cheaper and simpler system. Colour television for Britain—or the Continent—still looks, economically speaking, a long way ahead.

## Audio Exhibitions

FOR many years the annual exhibition organized by the British Sound Recording Association has had to turn away potential exhibitors—including many influential firms—for lack of space. The London Audio Fair\* held this month found room for most of the big firms in the industry, but was still not big enough for the comfort of the 23,000 people who turned up during the three days of the show. In spite of resourceful and imaginative handling of the crowds there were queues for admission and many demonstrations were fully booked hours in advance. Further expansion both in space and time is clearly indicated.

Both these exhibitions are held in hotels—as are the Audio Fairs in America—and it cannot be denied that an hotel with its numerous rooms and soundproof party walls is ready-made for comparative audio demonstrations. The corridors, too, are carpeted to deaden sound, though they are hardly designed to carry the counter-streams of purposeful enthusiasts in transit from one aural judgment to another.

Anything comparable with Television Avenue at the Radio Show is, of course, impracticable, but we do suggest that a standardized test piece might be made available to all exhibitors, either on tape or disc, to be played on demand for the benefit of those cynics who may think that demonstration pieces are invariably chosen to enhance the merits and obscure the faults of equipment. If the idea is acceptable in principle a sub-committee should be appointed without delay, for 12 months is all too short a time in which to reach agreement on what the test record should contain.

\*A report on sound reproducing equipment shown at this and other exhibitions will appear in an early issue.

# "Belt-and-Braces" Television Station

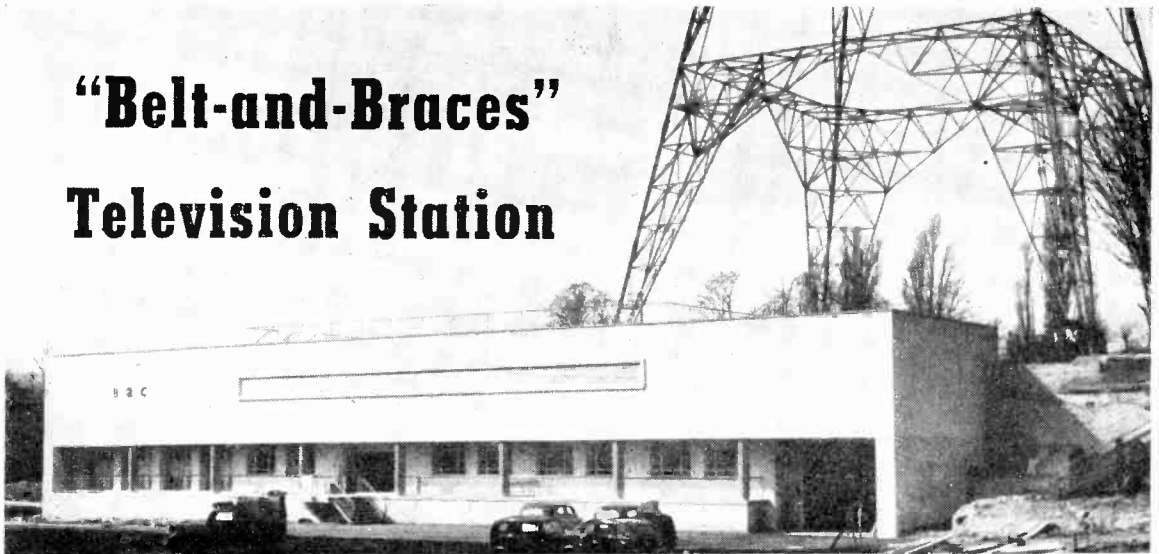

FEATURES OF THE NEW LONDON TRANSMITTER AT CRYSTAL PALACE

THE most noticeable thing about the design of the B.B.C.'s new television station at Crystal Palace is the elaborate precautions which have been taken to ensure continuity of service in the event of faults occurring on the equipment. Practically everything is duplicated. As can be seen from Fig. 1, there are two vision transmitters and two sound transmitters and two sets of crystal-drive equipment and video and sound input circuits. Even the aerial is arranged as two independently fed sections (it is actually a temporary aerial but the permanent one will be constructed on the same principle).

Under normal conditions all four transmitters are working simultaneously. The outputs of vision transmitter A and sound transmitter A are combined and fed to one section of the aerial, while the outputs of vision transmitter B and sound transmitter B are combined and fed to the other section. If there is a breakdown in one half of the system the other half continues operating—but giving, of course, a reduction in output power from the station of 6dB. In addition, however, there is a most elaborate switching system which enables various combinations of the pairs of transmitters and aerial

TECHNICAL DATA ON THE STATION	
<b>Vision Equipment (2 transmitters)</b>	
Frequency	45 Mc/s
Output power (each)	15 kW (peak white)
Frequency characteristic	vestigial upper sideband
Frequency response	< 1dB down at 2.75 Mc/s
Black level stability	better than $\pm 2\%$
<b>Sound Equipment (2 transmitters)</b>	
Frequency	41.5 Mc/s
Output power (each)	3.75 kW
Distortion	< 1% at 95% modulation
<b>Present Aerial (temporary)</b>	
Mast height	250ft.
Height of site	36ft. above sea level
Radiators	6 dipoles in two tiers of 3 (at 120° spacing)
Aerial gain	approximately 2:1
<b>Effective radiated power</b>	60 kW (vision), ultimately 200 kW

Our title picture shows a general view of the station with the permanent mast to the right. The building is actually sunk below the ground level of the Upper Terrace and looks on to the Lower Terrace of Crystal Palace.

Below: Fig. 1. Schematic diagram of the duplicate chains of transmitting equipment and switching arrangements.

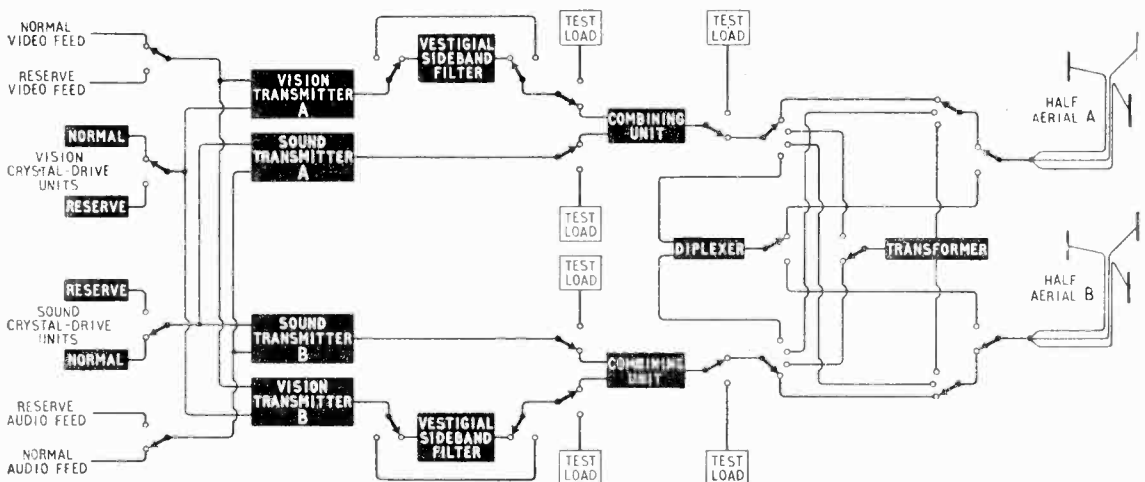

sections to be made. This is brought into action if the fault cannot be cured quickly, the idea being to permit a combination of transmitters and aerial sections that will give an output power reduced by only 3dB instead of 6dB. For example, both pairs of transmitters can be switched to either half of the aerial *via* the diplexer, or one pair of transmitters can feed both halves of the aerial *via* the transformer.

It can be seen that each transmitter has a test load, and this is used to enable any fault to be located and put right under running conditions while the rest of the station continues in operation. Also, the vestigial sideband filters can be short-circuited out if any trouble develops in them.

Incidentally, although both vision transmitters are fed from the same crystal drive unit (and likewise the sound transmitters), this in itself does not ensure that both r.f. outputs will arrive in their respective half-aerials in phase. So to prevent the embarrassing situation of one transmitter "pushing" while the other is "pulling," a phasing system has to be included in the equipment. This consists of a phase comparator working from pick-up points on the output feeders of both vision transmitters, A and B, and manual phase-shift controls in the drive inputs to the transmitters (with a similar arrangement on the sound transmitters). Any phase discrepancy between the two is indicated by a centre-zero meter in the phase comparator, and appropriate adjustments are made to the phase-shift controls to correct it.

Apart from the "belt-and-braces" system of operation the station has several other interesting features. It is rather surprising, for example, to find that the vision modulation, which is done at high level on the grids of the push-pull output stage, is achieved entirely with receiving-type valves! Until recently it was only possible to use such small valves for low-level modulation, but the situation has been changed in the Crystal Palace transmitter by the use of high-gain tetrodes for the output stage (two CR192s) which do not require a very large input. Previously grid-modulated triodes have been the rule. The higher gain of these tetrode output valves (coupled with the use of other tetrodes throughout the r.f. section) has also made possible a reduction in the number of r.f. stages required, and in fact the whole of

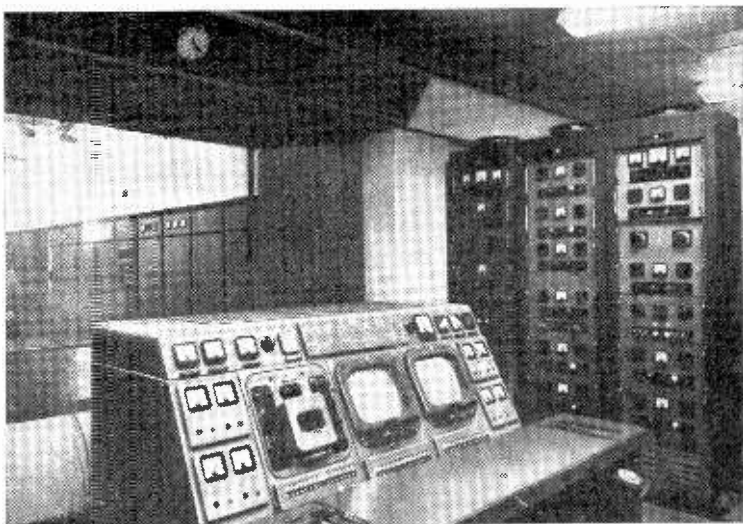

Main control desk, with a view through the window of the transmitter hall. The cubicles on the right contain the crystal-drive and phasing equipment.

the r.f. amplifying equipment is housed in a single cabinet only 2ft 6in wide and 7ft high. For obtaining the necessary bandwidth in the output stage a triple-tuned circuit is used in the anodes of the CR192 valves.

The output stage of the modulator actually uses KT67 receiving-type tetrodes in a "shunt-regulated" cathode-follower circuit. The purpose of the shunt regulation system is to maintain the linearity and frequency response of the modulator when it is working into the fluctuating load presented by the CR192 grid circuits of the modulated r.f. amplifier. This load consists of a capacitance and a shunt resistance which varies according to the grid current with different amplitudes of signal.

Another form of regulation in the vision transmitters is for stabilizing the black level of the radiated signal. This is a feedback system working from the transmitter output, and it uses the amplitude of the radiated sync pulses as a measure of black-level variation to apply a correcting signal to the "clamp" circuit which normally sets the black level in the modulator.

All the transmitters, drive equipments, combining units and feeders have been supplied by Marconi's.

## Amateur Colour Transmissions

THIS month British radio amateurs established what is believed to be a record by transmitting colour television signals over a 13-mile path. The colour equipment, built by C. G. Dixon, of Ross-on-Wye, has already been described in *Wireless World*.<sup>\*</sup> For this experiment, Mr. Dixon brought his colour monitor to the amateur receiving station G3CVO/T at Great Baddow, Essex, and left a colour-bar generator and control rack at the transmitting station G2WJ/T at Great Canfield, near Dunmow. The colour-bar generator produced vertical bars in green, black, red, yellow, cyan, blue, magenta and white.

For reception a converter was used to change the signal from 436Mc/s to 45Mc/s, this output being fed to a 9in television receiver for monochrome work, and into a "Pye strip" 45Mc/s amplifier and thence into the colour monitor. Mr. Dixon's equipment is field sequential, and runs at 150 lines, 100 fields per second, and thus is not compatible. The transmission path was established in monochrome on 405 lines, with two-way sound communication on 145.7Mc/s and 1.98Mc/s, and then switched to colour.

<sup>\*</sup>"Amateur Colour Television," *Wireless World*, April, 1954.

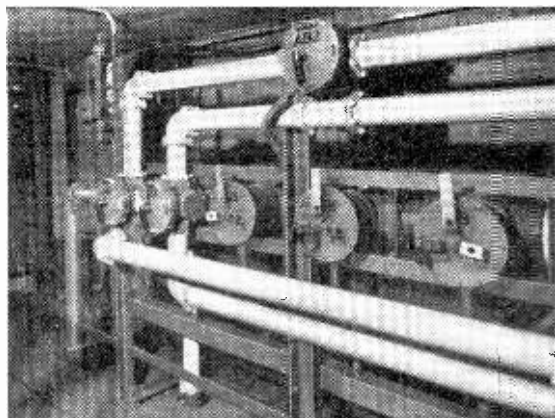

Coaxial feeder switching equipment in an upper room of the station. The functions of the coaxial switches here can be seen in Fig 1.

# WORLD OF WIRELESS

## Organizational, Personal and Industrial Notes and News

### National Electronics Show?

THE idea of a large-scale "professional" electronics exhibition covering all aspects of radio and its offshoots—except domestic broadcast receivers—has frequently been advocated by *Wireless World*. It is therefore gratifying to learn from the Radio Communication and Electronic Engineering Association that an Electronic Exhibitions Joint Association Committee has been formed to consider the whole question of national exhibition policy in the industries concerned.

The secretariat of the R.C.E.E.A. (11, Green Street, London, W.1) is acting for the committee on which is also represented British Electrical and Allied Manufacturers' Association, British Radio Valve Manufacturers' Association, Radio and Electronic Component Manufacturers' Federation and Scientific Instrument Manufacturers' Association.

### Physical Society Exhibition

ON May 14th the 40th exhibition of scientific instruments and apparatus, organized by the Physical Society, opens at the Royal Horticultural Society's Old and New Halls, Westminster, London, S.W.1. The number of exhibitors (131) is approximately the same as last year but, by utilizing both halls, there will be more space for visitors—a welcome change.

The exhibition opens on the first day at 10.30, but admission is limited to members and the Press until 2.0. On the 15th, 16th and 17th it opens at 10.0. Except on the last day when it closes at 5.0, it will remain open daily until 8.0.

At 6.15 on May 16th, G. G. Gouriet (B.B.C. Research) will give a lecture-demonstration on colour television.

Visitors' tickets are obtainable from the Physical Society, 1, Lowther Gardens, Prince Consort Road, London, S.W.7; a stamped addressed envelope should be enclosed.

### B.S.R.A. Show

THERE will be a 60% increase in the number of exhibitors at this year's show of sound recording and reproducing equipment organized by the British Sound Recording Association for May 26th and 27th at the Waldorf Hotel, Aldwych, London, W.C.2. Moreover, 25 of the 38 exhibitors listed below have this year booked individual demonstration rooms instead of sharing a communal demonstration room as has been done in the past.

- |                             |                         |
|-----------------------------|-------------------------|
| Acoustical Manufacturing    | Leevers Rich            |
| Ariel Sound                 | Lowther Manufacturing   |
| Armstrong                   | Lustraphone             |
| B-K Partners                | Minnesota Mining & Mfg. |
| Beam-Echo                   | M.S.S. Recording        |
| British Ferrograph          | R.C.A. Photophone       |
| Collaro                     | Resiosound              |
| Cosmocord                   | Rogers Developments     |
| C. T. Chapman (Reproducers) | Rudman Darlington       |
| E.M.I.                      | Simon                   |
| G.E.C.                      | Specto                  |
| Garrard                     | A. R. Sugden            |
| Goldring                    | Tannoy                  |
| Goodmans                    | Thermionic Products     |
| Goodsell                    | Truvox                  |
| Grundig                     | Vitavox                 |
| Kelly Acoustics             | Wharfedale              |
| H. J. Leak                  | Whiteley Electrical     |
| Lockwood.                   | <i>Wireless World</i>   |

The exhibition, which is the eighth organized by the Association, opens at 10.0 on both days and closes at 6.45 and 6.0, respectively. Admission is by catalogue, price 2/-, obtainable from S. W. Stevens-Stratten, 3, Coombe Gardens, New Malden, Surrey, after May 14th, or at the exhibition.

### 5,000,000 Components a Day

PRODUCTION of radio and electronic components, which last year rose by 30% compared with 1954, has doubled during the past four years and is now seven to eight times the pre-war level. Five million components are now made every working day, according to 23rd annual report of the Radio and Electronic Component Manufacturers' Federation.

Exports, including components for sound reproduction equipment, were valued at £13.4M in 1955, an increase of nearly 23% on the previous year. The United States is now the principal British market for high-quality sound reproduction equipment and India the largest purchaser of components.

The report points out that while

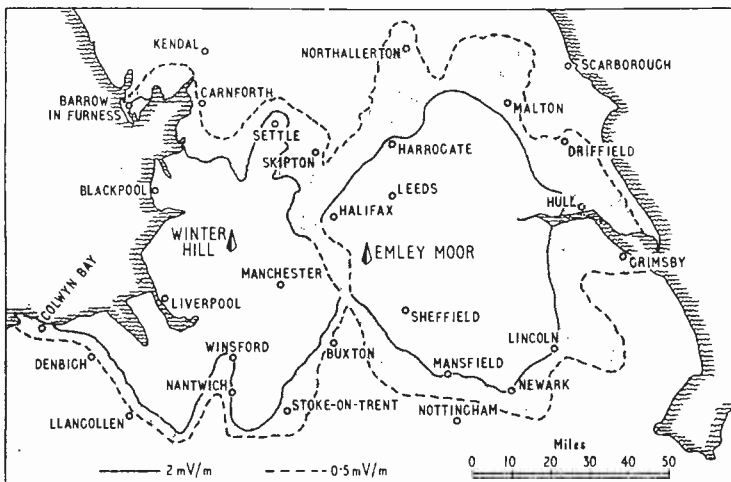

THE FIRST of the I.T.A.'s northern transmitters—at Winter Hill, Lancs. (channel 9)—opens on May 3rd. The anticipated overall coverage in the northern region when the second station—on Emley Moor, Yorks. (channel 10)—opens in the autumn, is shown on this map.

the sound and television receiver industry remains the principal single consumer of components (amounting to 48.5% in quantity and 42.2% in value) there is a rising demand in all sections of the industries served. Radio communications and radar gear take 14.8% of the output of component manufacturers, telecommunications gear 5%, sound reproduction equipment 4.4% and defence, instrumentation and industrial electronics, etc., 8.8%. The remaining 18.5% is exported.

## PERSONALITIES

**S. M. Aisenstein**, a pioneer of wireless and one of the world's foremost valve designers, has retired from the position of general manager of the English Electric Valve Company, which he has held since the company was formed in 1947. He is being retained as a consultant on vacuum physics by the English Electric Group. A native of Kiev, he formed a wireless company in Russia in 1907 and at Guglielmo Marconi's invitation came to England in 1908. Three years later the Russian company, with Mr. Aisenstein as director and principal technical adviser, coalesced with the Marconi Company. In 1922 he was appointed to a company established by Marconi's in Poland and three years later went to Czechoslovakia, where he set up a valve manufacturing company. For some years prior to the formation of the English Electric Valve Company he was in charge of the Marconi valve laboratories at Chelmsford.

**Dennis Gabor**, Dr. Ing., M.I.E.E., F.Inst.P., Mullard Reader in Electronics at the Imperial College of Science and Technology, London, has been elected a Fellow of the Royal Society "for his work on transient electric phenomena, electron microscopy, the theory of communication and the electric arc plasma." Dr. Gabor was born in Hungary, studied in Budapest and at the Technische Hochschule, Berlin-Charlottenburg. His thesis, in 1927, was on one of the first high-speed cathode-ray oscillographs with internal photography—the first in which transients photographed themselves by releasing a bistable electronic circuit. Incidentally, the name "Kipprelais" which he gave to the circuit caused many English readers to think that it was invented by a Dr. Kipp but, of course, in German "kippen" means toggling or tumbling. He came to this country in 1934 and worked until the end of 1948 in the research laboratory of the British Thomson-Houston Company, Rugby, during which time he was engaged on communication theory and speech frequency band compression. Dr. Gabor has been at Imperial College since 1949 and has recently been developing a flat, thin, neckless tube for monochrome and colour television, details of which we hope to be able to publish in the near future.

**H. A. Fairhurst**, who in this issue contributes the concluding part of his article describing an experimental colour receiver, has been with Murphy Radio since 1936 and is at present head of the television research section of the company's electrical design laboratory. He has done original work on a method of producing framing pulses for interlaced scanning and on the suppression of the effects of impulsive interference on television sound reception. Mr. Fairhurst graduated from the Royal School of Mines in 1925 and was working as an exploration geologist in Mexico before turning to radio research in the early 'thirties.

**R. W. Addie**, M.A., who for the past five years has been manager of the technical-commercial department of Philips which he joined in 1946, has been appointed assistant commercial manager. He will act as deputy to **A. L. Sutherland**, director in charge of television and radio. Mr. Addie, who graduated from Cambridge in 1939 with a degree in engineering, has for the past few years been largely responsible for the sound and television relay installation at the National Radio Show.



R. W. ADDIE.



M. A. E. BUTLER.

Philips' new technical-commercial manager is **M. A. E. Butler**, M.A., who joined the company as an engineer in 1951. He was educated at Oxford and holds an honours degree in physics and a degree in mathematics. After service as signals officer in the R.A.F. he joined the staff of the research laboratories of Standard Telephones and Cables before going to Philips.

**J. A. Pim**, B.Sc.(Eng.), Ph.D., M.I.E.E., has been appointed chief engineer of the new telecommunication transmission division of Siemens Brothers (see "Business Notes"). Dr. Pim joined the company in 1948 from University College where he had been engaged in research for two years. He was, from 1942 to 1946, at the Royal Aircraft Establishment, Farnborough.

## OBITUARY

**Norman C. Robertson**, C.M.G., M.B.E., deputy managing director of E. K. Cole, Limited, and a director of Ekco Electronics, Limited, died on April 1st, aged 47. Before going to Ekco in 1930 as chief of test, he held a similar position with Kolster-Brandes and had for a short while been with Marconi's. He had been deputy managing director since 1945, having successively been production manager and works manager. In 1951 Mr. Robertson accepted the then newly-created position of director-general of electronics production at the Ministry of Supply. He returned to E. K. Cole in 1953 and the following year was appointed C.M.G. for his two years' voluntary service with the Ministry.

**Harold E. Penrose**, A.M.I.E.E., who died recently at the age of 69, started his radio career with the Marconi Company as marine operator. For a short while immediately after the first world war he was on the editorial staff of *Wireless World*. He went into the broadcast receiver industry in 1929 as sales supervisor, H.M.V., and had since then held positions with a number of companies, including E.M.I. and Rediffusion.

## IN BRIEF

During February the number of television licences in the United Kingdom increased by 110,654, bringing the total to 5,649,266. The total number of **broadcast receiving licences** in force at the end of February, including those for television and 291,740 for car radio, was 14,230,519.

In a breakdown of television licence figures for the

We regret that publication of this issue has been delayed. Subsequent issues will appear at intervals of less than a month until the normal time of publication is resumed.

end of December, issued by the G.P.O., 34 towns and districts showed an excess of television licences over sound licences, 19 were around London, 11 in the Midlands and four in the North. Of the English counties, Lancashire and Yorkshire lead with 682,579 and 550,904, respectively. In the London Postal District there were 632,703.

**Demonstrations** are being given at various harbours in the United Kingdom by Elliott Brothers of a commercial version of the microwave course beacon described in our November, 1955, issue. Forthcoming demonstrations are: Lossiemouth—April 30 and May 1, Whitehaven—May 3 and 4, Fleetwood—May 7 and 8.

**Brigg's Festival Hall Concert.**—In addition to the advertised programme of live and recorded music, a demonstration of stereophonic reproduction using British and American tapes will be included in the concert on May 12th. At the time of going to press all the cheaper seats had been sold, but tickets at 8s 6d were still available from "hi-fi" dealers in London, the Royal Festival Hall box office or direct from Wharfedale.

**B.B.C. Moscow Visit.**—In May a B.B.C. delegation is going to Moscow at the invitation of the Soviet broadcasting authority. It will be recalled that a Soviet broadcasting delegation visited this country at the invitation of the B.B.C. last autumn. R. T. B. Wynn, B.B.C. chief engineer, is a member of the seven-man delegation.

**Morse Test Fees.**—The fee chargeable by the Post Office to prospective amateur licence holders for a Morse test has been increased from 7s 6d to 10s. Tests are conducted on request at the G.P.O. headquarters (St. Martin's-le-Grand, London, E.C.1), Post Office coast stations and at the radio surveyor's office at certain ports.

**Transistor sales** in the United States trebled in 1955 by comparison with the previous year. Figures issued by the Radio-Electronics-Television Manufacturers' Association of America are: 1954—1,317,327; 1955—3,646,802.

**I.T.A. over the Border.**—The Independent Television Authority has selected a site for its first Scottish transmitter, although authority to erect the station has yet to be granted. The site is at Black Hill, Lanarkshire, midway between Edinburgh and Glasgow and about two miles from the Kirk o' Shotts transmitter of the B.B.C. It is about 800 feet above sea level.

**R.E.C.M.F. Council.**—At the annual general meeting of the Radio and Electronic Component Manufacturers' Federation on March 21st, the following member firms were elected to form the council (names of the companies' representatives are in parenthesis): Garrard (H. V. Slade), A. H. Hunt (S. H. Brewell), Morganite Resistors (E. T. Treganza), Multicore (R. Arbib), Plessey (P. D. Canning), Standard Telephones and Cables (E. E. Bivand), Telegraph Condenser Company (W. F. Taylor), Telegraph Construction and Maintenance Company (W. F. Randall) and Henry Wiggin (J. S. Mason). In addition Giesham Transformers (J. P. Coleman), N.S.F. (K. G. Smith), and Reliance Electrical Wire (C. H. Davis) were co-opted to the council. The new chairman is S. H. Brewell and the vice-chairman Richard Arbib.

**R.C.E.E.A. Council.**—There is no change in the representation of member companies on the council of the Radio Communication and Electronic Engineering Association. The member firms and, in parenthesis, their representatives forming the 1956-57 council are: B.T.H. (V. M. Roberts), Decca Radar (C. H. T. Johnson), E.M.I. (S. J. Preston), G.E.C. (M. M. Macqueen), Kelvin & Hughes (C. G. White), Marconi's (F. S. Mockford), Metrovick (L. H. J. Phillips), Mullard (T. E. Goldup), Murphy (K. S. Davies), Plessey (P. D. Canning), Redifon (B. St. J. Sadler) and S.T.C. (L. J. I. Nickels). Last year's vice-chairman, C. H. T. Johnson, is now chairman and the new vice-chairman is S. J. Preston who was chairman last year.

## EXHIBITION NEWS

One hundred firms had taken all the available space for the **National Radio Show** (Earls Court, August 22nd to September 1st) over four months before the opening.

Electronics as an aid to materials handling will be exhibited and demonstrated by a number of firms at the **Mechanical Handling Exhibition** at Earls Court, London, from May 9th to 19th. Admission to the exhibition, organized by *Mechanical Handling*, and the international convention held in conjunction with it, costs 2s 6d. It is open daily, except Sunday, from 10 to 6.

A v.h.f./u.h.f. convention is being organized by the Radio Society of Great Britain and the London U.H.F. Group for May 26th at the Bonnington Hotel, Southampton Row, London, W.C.1. It will include an exhibition (which opens at 10), technical lectures, discussions and a dinner in the evening. Among the lectures, which begin at 2.30, is one on "Some aspects of forward scatter." Tickets, price 3s 6d, for the exhibition and convention, may be obtained from F. G. Lambeth (G2AIW), 21, Bridge Way, Whitton, Twickenham, Middlesex, from whom tickets for the lunch and dinner are also obtainable.

Twenty-nine firms are participating in the exhibition, "**Atoms, Electrons and Industry**," which the electronics section of the Scientific Instrument Manufacturers' Association is organizing for June 6th to 8th at the Royal West of England Academy, Bristol. Admission is by ticket obtainable free from S.I.M.A., 20, Queen Anne Street, London, W.1.

The products of over forty companies, the majority foreign, will be shown at the second **International Instrument Show** which is being organized by B & K Laboratories Limited at Denison House, Vauxhall Bridge Road, London, S.W.1, from May 7th to 18th. The firms exhibiting are: U.S.A.—Advance Electronics, Allen-Bradley, Ampex, Brush, Electrical Industries, Electro-Voice, Electronic Tube Corp., Heath, M.B. Mfg. Co., Narda, New London Instrument Co., Polarad, Polytechnic R. & D., Raytheon, Sperry, Sprague, Sylvania, Varian; Switzerland—Metrohm, Muller-Barbieri, Vibrometer; Denmark—Bruel and Kjaer; Holland—Peekel Laboratories; Sweden—Sivers Lab.; Italy—Firar; France—Detectron; Germany—Hackethal, Linde, Belzer, Grundig; U.K.—Avo, Advance Components, G. & E. Bradley, Cinema Television, Clarke and Smith, Cossor, Furzehill, Grayonics, Kelly, Microwave Instruments. Tickets are obtainable from the organizers at 57 Union Street, London, S.E.1.

The system of electronic machine tool control, which was mentioned in our February issue, is being featured by E.M.I. Electronics at the **Production Exhibition** which opens at Olympia, London, on May 23rd for eight days. A number of other applications of electronics to production will be included in this second exhibition sponsored by the Institution of Production Engineers.

## BUSINESS NOTES

**Siemens Brothers** have formed a telecommunication transmission division which will be responsible for the development, manufacture, sales and installation of all radio-line terminal equipment, multi-channel carrier telephone and voice-frequency equipment and voice-frequency telegraph apparatus. Dr. J. A. Pim is chief engineer (see "Personalities").

The B.B.C. has ordered 17 of the new **Emitron** television cameras which are mentioned in our review of the Television Society exhibition (see page 164). To enable the operator to maintain a comfortable stance the electronic view-finder can be kept horizontal when the camera is tilted for high- or low-angle shots.

The entire fleet of Bristol Britannia aircraft operated by B.O.A.C. is to be fitted with **Ekco** search radar for the detection of turbulent cloud formations.



**H.M.V.-R.C.A. Break.**—As from May next year new H.M.V. recordings will be released in the United States and Canada by Electric and Musical Industries Limited through their own companies. From that date new recordings issued in the United States by Radio Corporation of America will no longer be released in the United Kingdom by the Gramophone Company.

**Decca-R.C.A. Agreement.**—Following the above announcement the Decca Record Company stated that they had acquired the right to manufacture and sell as from May 1st, 1957, all new R.C.A. Victor recordings. A year later all R.C.A. Victor records will be available for manufacture and sale by Decca under the R.C.A. label.

A company under the title of **Siemens-Ediswan Limited** has been formed to fuse the interests of Siemens Brothers and Company with those of the Edison Swan Electric Company. The two companies will continue to trade as independent concerns but matters relating to research, development, manufacture and distribution will be co-ordinated. Dr. J. N. Aldington has been appointed managing director of Siemens-Ediswan.

**Marconi-A.T.&E. Co-ordination.**—The Automatic Telephone & Electric Company and Marconi's Wireless Telegraph Company have concluded an agreement for co-operation in the field of telecommunications. The development, production, planning, installation and maintenance resources of the two companies will be co-ordinated, to enable them jointly to meet the widest possible range of telecommunication requirements.

All valves previously sold by the General Electric Company under the trade mark **Osram** will in future bear the trade mark **G.E.C.** This change applies only to valves and not to other products using the Osram trade mark.

An agreement between **E.M.I. Electronics Ltd.**, of Hayes, and **Industrial Electronics**, of Magnet Works, Derby Road, London, S.W.14, provides for E.M.I. to act as sole selling agents at home and overseas for the instruments produced by Industrial Electronics.

**Cossor** announce the signing of an agreement between themselves and **K.G.H. (Holdings) Pty. Ltd.**, of Sydney, Australia, whereby "the Australian company obtains the full present and future know-how of the English company in the design and production of television receivers." Cossor television receivers will be marketed in the Commonwealth by Jacoby, Mitchell and Co. Pty. Ltd. (Cossor agents) and Titanvision receivers by K.G.H.

A substantial interest in **W. Watson and Sons, Ltd.**, of Barnet, the manufacturers of the zoom lens used in television cameras, has been acquired by **Pye Ltd.** Founded in 1837, Watson's are primarily optical and scientific manufacturers.

**Honeywell-Brown Ltd.**, of 1, Wadsworth Road, Perivale, Middlesex, are to manufacture and market the micro-switches developed by the Minneapolis Honeywell Regulator Company, their American associates. The overall size of one type, which will carry 5 amps at 250 volts A.C., is approx.  $\frac{3}{4}$ in  $\times$   $\frac{1}{2}$ in  $\times$   $\frac{1}{4}$ in.

**Pye** telecommunications equipment was used for ground-to-air communication during the record breaking flight of the **Fairey Aviation Company's Delta 2**. The aircraft was tracked by radar and the pilot informed by radio when he was entering and finishing the measured course.

**E. K. Cole Limited** announce that **Ekco** electronic equipment plays an important role in the "Fairey Fireflash" guided weapon system, which is now in production for the **R.A.F.**

Cable markers, or printed sleeves, in rubber, synthetic rubber or P.V.C., indelibly printed with any wording, are now available from **Creators Limited**, Plansel Works, Sheerwater, Woking, Surrey, at twenty four hours notice.

**A.E.I.-Ekco Link.**—Negotiations are under way for the formation of an Australian company to be owned jointly by Associated Electrical Industries Limited and E. K. Cole Limited. The new factory will be at Yennora, near Sydney, and is expected to be producing receivers by the time a television service is started in the Commonwealth.

**Lithgow Electronics Limited**, of 1, Grange Court, Sudbury Hill, Harrow, Middlesex, have been appointed sole representatives in the United Kingdom and Eire of the **Hewlett-Packard Company**, instrument manufacturers, of California, U.S.A. The servicing of the equipment will be undertaken by **Livingston Laboratories Limited**, of Retcar Street, London, N.19.

## OVERSEAS TRADE

**January Exports.**—After a record-breaking year in 1955—as reported last month—exports of radio equipment of all kinds in January were valued at £2.9M, a record for the first month of a year. Export figures for each section of the industry were higher than the corresponding values for January, 1955.

**Canada.**—Contracts valued at \$200,000 for the supply of telecommunication measurement equipment to the Canadian Department of Defence have been awarded to **Marconi Instruments**. The contracts, which were secured in conjunction with the Canadian **Marconi Company** "in face of severe competition from American organizations," are for frequency meters, wattmeters, universal bridges and signal generators—one f.m. signal generator having been specially designed to conform to North American standards.

**Switzerland.**—Under a contract recently concluded between **20th Century Electronics**, of New Addington, Surrey, and **Landis and Gyr**, of Zug, Switzerland, 20th Century cathode-ray and geiger tubes will be marketed exclusively in Switzerland by the Swiss company and in Western Germany by their associates, **Paul Firchow Nachfolgen**. The licence also provides for the British company to train foreign engineers and allows the overseas parties the right to use British designs and patents.

**Paris.**—Radio-telephone equipment for fifty Parisian taxis—said to be the first radio-equipped taxis in the city—has been supplied by **Pye Telecommunications**.

**Iraq.**—Redifon radio-telephone equipment has been installed at Iraq's Kirkuk oil-field and the refinery at Daura, near Baghdad. This will enable information on tankage capacity and the different kinds of oil being pumped to be passed continuously between the two centres.

Only three of the eighty or so British manufacturers who exhibited at the **Lyons International Fair** (April 7th to 16th) are in the radio industry. They are **Erie, G.E.C.**, and **S.T.C.**

**Hungary.**—Television outside broadcasting equipment is being provided by **Pye** for the Hungarian television service which is to be inaugurated later this year.

**Norway**, which has had an experimental v.h.f. broadcasting station operating for some time, has recently ordered eleven 5-kW f.m. transmitters from **Marconi's**.

**Canada.**—Decca surveillance radar equipment is being supplied to the Canadian Department of Transport for the airports at Toronto, Montreal, Winnipeg and Vancouver.

**Borneo.**—A v.h.f. radio-link has been supplied by **Automatic Telephone & Electric Company** to the broadcasting organization in British Borneo to feed **B.B.C.** news bulletins, received at Batu Kawa, to the main studios at Kuching five miles away.

**Karachi.**—Equipment for a number of fixed and mobile radio-telephone stations has been supplied by **Intercommunications Equipment Company**, of 286-288, Leigh Road, Leigh-on-Sea, Essex, to the police force in Karachi, Pakistan.

# Low-Distortion F.M.

## Resistance-Coupled Pulse-Counting Circuit Needing No Alignment

**I**N the July 1955 issue there was a letter from J. K. Carter entitled "F.M. Receiver Design" in which he inquired "What has happened to Thomas Roddam's circuit? Does it really work?" The circuit to which he referred was described in the July 1948 issue under the title "Why Align Discriminators?" and took the form of a simple pulse counter instead of one of the usual phase discriminators with their need for accurate and skilled alignment.

Investigation of this circuit supplies the answer, which is a definite "Yes." It works very well. It gives the home constructor f.m. reception without the daunting problem of aligning discriminators and i.f. amplifiers and also without the 3% distortion of which Mr. Carter complained. And a receiver incorporating it can be actually cheaper and simpler than conventional designs. As Mr. Roddam pointed out, however, its advantages are at the expense of efficiency (in the technical sense), so are most readily obtainable where there is a fairly strong signal, say within the 1 mV/m contour. There seems to be no reason, however, except for some sacrifice of simplicity, why this discriminator should not be used in a highly sensitive receiver.

In order to understand clearly what is involved in its design, let us begin at the beginning.

The process of frequency modulation varies the number of signal cycles entering the receiver per given small period of time. Fig. 1(a) shows (somewhat exaggeratedly) two such periods, at opposite peaks of modulation. The problem is to derive an output signal that is continuously proportional to the number of cycles. It is not enough simply to rectify the incoming signal, as at (b); the rectified output is constant, because each increase in number of cycles is exactly balanced by their reduced duration. But if the signal cycles are employed to generate pulses all of equal size, as at (c), their mean value over the period (indicated by the height of the dotted line) is exactly proportional to their frequency, which is the same as that of the f.m. signal, and so the requirements of a discriminator are fulfilled.

The first practical problem is to ensure that the pulses are all the same size, regardless of frequency and amplitude of the signal. This is easier than might be expected. Their "size" is the number of volt-seconds, represented on voltage/time graphs

such as Fig. 1 by area. If the voltage is caused by a quantity of electricity passing through a resistance, then (since quantity is the number of amp-seconds, called coulombs) all that is necessary is to ensure that the resistance and the quantity are the same for each.

If, in Fig. 2, the slider is moved from  $V_1$  to  $V_2$  the difference  $V_2 - V_1$  being  $V$  volts, then the quantity of electricity flowing through  $R$  during the time necessary for this difference to occur across  $C$  is  $VC$  coulombs, and the size of the voltage pulse across  $R$  is therefore  $VCR$  volt-seconds. There is of course no difficulty in keeping  $C$  and  $R$  constant; and  $V$  can be made the same each time, in spite of variations in signal amplitude, by deriving it from a limiter stage, as in receivers employing the Foster-Seeley discriminator.

Note that the size of the pulse does not depend on the time taken for the voltage change to take place at the source. But time must be allowed for the pulse to be practically completed before the source voltage starts to reverse. A sinusoidal signal, as in Fig. 1(a), would not do, because it starts to reverse immediately it reaches its peak in either direction. But the limiter can be used to distort the sine wave into something nearer a square wave, whose flat top allows some time for the charging of  $C$ , delayed by  $R$ , to continue. The important thing is that it should always allow enough time. If the longer cycles on the left of Fig. 1, corresponding to negative peak modulation, did allow enough time, and the shorter pulses on the right, corresponding to positive peaks, did not, the pulses would not all be exactly the same size, so the mean value would not be exactly proportional to frequency and the a.f. output would be distorted.

Fig. 3 shows the pulse-forming circuit driven by a limiter stage of the type proposed by Roddam. When an adequate signal is supplied to the grid, the valve alternately "bottoms" and is cut off. In the bottomed condition the anode voltage is quite low, and when cut off it rises to the full supply voltage  $V_b$ . It cannot do so instantaneously, however, even if for simplicity we suppose that the anode current is cut off instantaneously. Let us follow the action in detail, beginning with the bottomed condition. Assuming it has lasted long enough for the

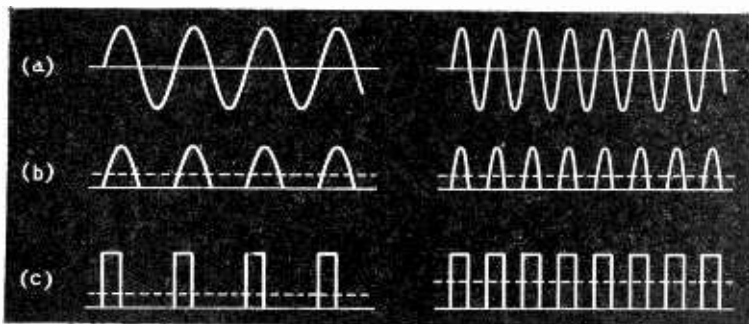

Fig. 1. At opposite peaks of modulation, a f.m. carrier wave has different numbers of cycles in a given period of time, as shown at (a). The rectified and smoothed output (b) is the same for both, but if pulses of constant size are substituted (c) the output, shown dotted, is exactly proportional to frequency.

# Discriminator

By M. G. SCROGGIE, B.Sc., M.I.E.E.

voltage across C to become constant, there can be no current flowing through R and so no voltage across it, and point *c* in Fig. 3 must be at the same potential as *e*, as shown at the start of Fig. 4. The large anode current through  $R_a$  brings the anode *a* down to, say, 25 volts, which is therefore the voltage across C.

Now suppose the anode current is instantaneously cut off. The voltage  $V_b$  from *e* to *b*, being kept constant by a smoothing capacitor, remains unchanged, say at 125 volts. The voltage across C cannot alter instantly so is still 25, therefore the remaining 100 must divide between  $R_a$  and R in proportion to their ohms. It is this that gives the sudden voltage peak across R. Roddam calculated it to be 50 volts, but this is impossible with the values he chose ( $V_b = 70$ ,  $R_a = 10\text{ k}\Omega$  and  $R = 1\text{ k}\Omega$ ). The current now flowing through  $R_a$  and R proceeds to charge C towards 125 volts. The nearer it approaches, the less the voltage left to drive the charging current through  $R_a$  and R, so the charging current and the voltage across C die away in the manner called exponential, as shown by *c* in Fig. 4. The anode potential *a* meanwhile rises in the same manner towards *b*. Theoretically this process goes on for ever, and as we cannot wait so long we have to decide on the stage at which it can be deemed to be finished.

The rate of decay is determined by C and the resistance through which it is charged ( $R_a + R$ ). In the period known as the time constant,  $= (R_a + R)C$ , the voltage has dropped to 36.8% of its starting value. With this particular shape of curve, the percentage of pulse "area" that remains to come (if it went on for ever) happens conveniently to be equal to the percentage of voltage remaining at that point; 36.8% is of course far too much to neglect. Roddam chose four times the time constant, on the supposition that by then the voltage had dropped below 1%, but this is incorrect; it is still 1.8%. Suppose we decide on five times, at which only 0.7% of the pulse is left. This, then, is the minimum allowable time for the positive half of the square wave. Assuming that it actually is a half, then the shortest whole cycle is  $10(R_a + R)C$  and the highest allowable signal frequency is therefore  $1/10(R_a + R)C$ .

To obtain proper limiting action,  $R_a$  ought not to be too small; neither ought R if a reasonable output is to be obtained. So one would be inclined not to go below  $10\text{ k}\Omega$  for  $R_a + R$ . C ought to be sufficiently large for stray capacitances not to matter; say, not much less than about  $40\text{ pF}$ . Filling in these values, we get as the highest frequency  $250\text{ kc/s}$ . This being at the positive peak of modulation, the carrier frequency for a deviation of  $75\text{ kc/s}$  would be  $175\text{ kc/s}$ , and the minimum  $100\text{ kc/s}$ . One could go somewhat lower, say  $50\text{ kc/s}$ , without running into difficulty in separating it from the highest a.f., and a margin at least as wide as this is most desirable in order to allow for inaccuracy or drift of tuning. "Carrier frequency" through-

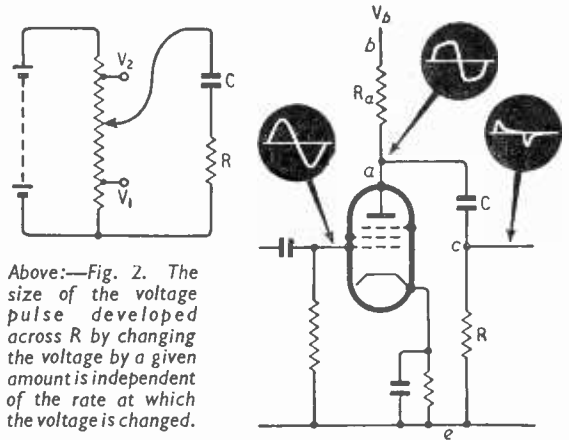

Above:—Fig. 2. The size of the voltage pulse developed across R by changing the voltage by a given amount is independent of the rate at which the voltage is changed.

Above right:—Fig. 3. Outline of circuit for producing equal voltage pulses from a signal of varying frequency.

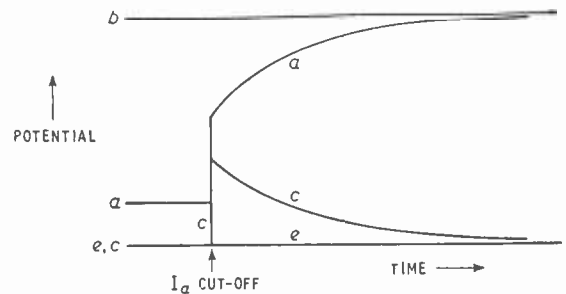

Fig. 4. If the anode current in Fig. 3 is cut off instantaneously by the down swing of a large input signal, the potentials of the various points are affected as shown. The desired voltage pulse is obtained at *c*.

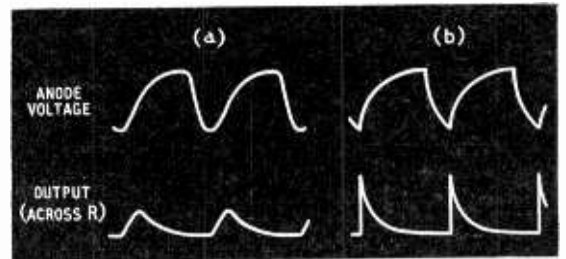

Fig. 5. Actual waveforms obtained in a circuit of the Fig. 3 type (with rectifier added to remove negative pulses), with (a) small and (b) large input signal amplitudes. Despite the very different peak values and shapes of the output pulses, they are equivalent, thanks to the principle illustrated in Fig. 2. The output pulses at (b) are very close to the theoretical shape—*c* in Fig. 4.

out this article refers, of course, to the frequency to which the carrier actually broadcast is reduced by means of the receiver's frequency changer. It occupies the centre of the i.f. band, which, as we have just found, extends in this type of receiver from about  $50$  to  $250\text{ kc/s}$ .

It may be objected that the foregoing calculation is unsound, being based on the assumption of a perfect square wave, allowing a complete half-cycle for dying-away purposes. But the larger the proportion of the half-cycle occupied by the sloping rise, the greater the proportion of the pulse that

occurs before the exponential tail, and the less it matters if that tail is slightly clipped. Moreover, if the limiter circuit is as shown (Fig. 3), without series grid resistance, grid bias is automatically developed which extends the cut-off period well beyond half the cycle, allowing more time for the pulse. Fig. 5 shows actual waveforms with small (a) and large (b) inputs. In spite of their greatly different shapes and peak values, the mean values of the two lots of output pulses are the same within very close limits over a 100-to-1 input voltage ratio. This perhaps rather surprising result is due to the simple basic principle with which we began, that the quantity of electricity required to charge a given capacitance to a given voltage is quite independent of the time and rate of charging.

Another objection that will no doubt be raised—and this time rightly—is that the circuit so far shown would on the down swings produce negative pulses, and these are not shown in Fig. 5. They can be eliminated by cutting off R from negative voltages by a diode,  $D_2$  in Fig. 6. C is meanwhile

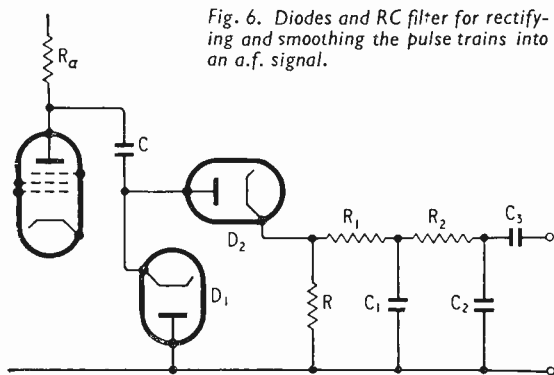

Fig. 6. Diodes and RC filter for rectifying and smoothing the pulse trains into an a.f. signal.

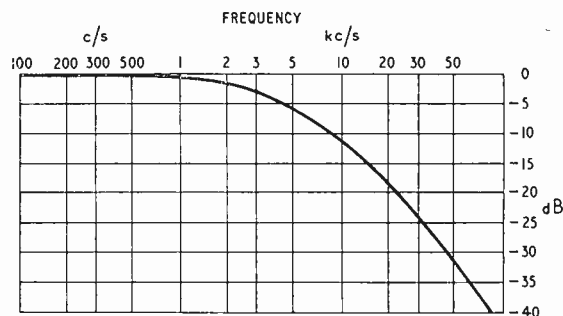

Fig. 7. Measured frequency characteristic of output filter with component values as in Fig. 9.

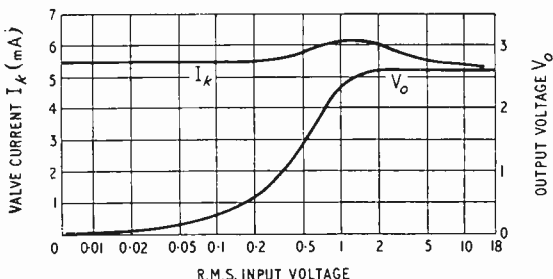
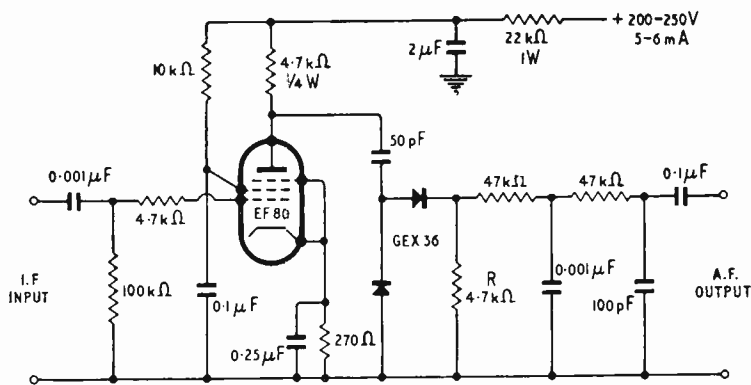

Fig. 8. Z.f. output across R ( $V_o$ ) and cathode current ( $I_k$ ) against r.m.s. input voltage: circuit as in Fig. 9.

being discharged via  $D_1$ . Obviously these diodes should have as low forward resistances as possible, so as not to increase the time constants appreciably. Satisfactory results have been obtained both with an EB91 thermionic double diode and a pair of GEX36 germanium diodes, the latter being of course neater and more convenient. Care should be taken to connect them as shown, so that the positive pulse is the one used; this is to allow it the longer "half"-cycle in which to take place. The negative pulse can make do with the shorter half because it has a shorter time constant, R then not being in circuit.

As the received signal is modulated, the pulses across R alternately close up and open out their ranks, so the average voltage across R rises and falls at modulation frequency. To prevent the relatively high peak voltages reaching the a.f. amplifier, some filtration is needed. An elaborate inductive filter is unnecessary, for a good start is made by the de-emphasis circuit that would in any case be needed to reduce the upper audio frequencies deliberately over-emphasized at the transmitter. The correct amount is provided by a CR potential divider having a time constant of  $50 \mu\text{sec}$ ; that is to say,  $C_1 R_1 = 50 \times 10^{-6}$ . At the same time  $R_1$  must be large enough not to shunt R heavily; about  $50 \text{ k}\Omega$  is suitable, in which case  $C_1$  would be  $50 \times 10^{-6} / (50 \times 10^3) = 10^{-9} \text{ F}$  or  $1,000 \text{ pF}$ . As this alone gives only a 6-dB per octave slope-off, which is scarcely enough for filtration, it may be supplemented by  $R_2$  and  $C_2$ , designed not to increase the a.f. cut-off appreciably but to reduce the lowest i.f. If  $R_2$  is also  $50 \text{ k}\Omega$  and the cut-off frequency ( $-3 \text{ dB}$ ) is  $30 \text{ kc/s}$ ,  $C_2$  works out at about  $100 \text{ pF}$ . The two-stage filter just specified gives slightly more cut than that calculated on a separate-stage basis, and the standard values  $47 \text{ k}\Omega$  were in fact adopted. The filter is suitable for connecting through a blocking capacitor  $C_3$  to an a.f. amplifier having an input resistance not much below  $0.5 \text{ M}\Omega$  and capacitance not much more than  $10 \text{ pF}$ . Fig. 7 shows the measured voltage/frequency characteristic.

We have estimated that  $R_a + R$  should preferably not exceed about  $10 \text{ k}\Omega$ , but the best individual values have yet to be settled. We know that for a given V—the difference in anode voltage between the bottomed and cut-off states—the output is proportional to R. If  $R_a + R$  is kept constant and R is increased from zero, the output is at first proportional to R; but as  $R_a$  falls, V falls at an increasing rate until at a certain ratio of R: $R_a$  it balances the increase due to R. That is the optimum as regards magnitude of output, and with an EF80 high-slope pentode at  $V_b$  equal to 80 to 100 volts it turned out to be  $6.5 \text{ k}\Omega$  for R to  $3.5 \text{ k}\Omega$  for  $R_a$ . As  $R_a$  is reduced, however, the limiting action becomes less good and valve currents increase; so, since  $5 \text{ k}\Omega:5 \text{ k}\Omega$  gives nearly as much output that ratio was adopted. It gives about four times the output of the  $1 \text{ k}\Omega:10 \text{ k}\Omega$  ratio, the five-fold increase in R being offset by only a 20% reduction in V due to the halving of  $R_a$ . Indirectly, the increase in R: $R_a$  ratio yields a further increase in output, because the difference between the time constants  $(R_a + R)C$  and  $R_a C$  for positive and negative pulses respectively enables a larger proportion of the cycle to be allowed for the positive pulse and hence a greater mean pulse voltage. It



Above:—Fig. 9. Recommended circuit of limiter and discriminator.

Above right:—Fig. 10. Departure of  $V_o/f_c$  curve from linearity in Fig. 9 circuit. The values of  $V_o$  if linearity were perfect, from which  $\delta V$  must be subtracted to give the actual curve, are shown along the top.

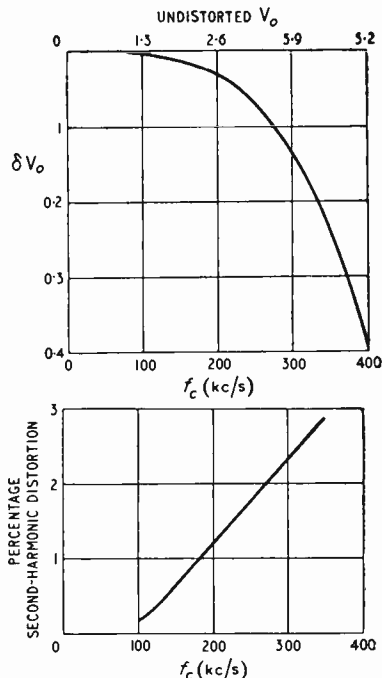

Right:—Fig. 11. Second-harmonic distortion due to non-linearity shown in Fig. 10, for 75 kc/s deviation, plotted against carrier frequency,  $f_c$ . All other harmonics are extremely small.

has, in fact, been found quite feasible to raise  $C$  to 50 pF, giving a proportionate increase in output.

These benefits in output are welcome, because the efficiency of this type of discriminator is admittedly low. The output can easily be calculated, by assuming instantaneous  $I_a$  cut-off and making use of the fact that the pulse is then equivalent to one maintaining the same peak value for  $(R_a + R)C$  seconds. The peak output voltage is  $VR/(R_a + R)$ , and its mean value  $V_o$  is given by multiplying this by the ratio of  $(R_a + R)C$  to the period of one signal cycle, which at the carrier frequency  $f_c$  is  $1/f_c$ . So

$$V_o = VRCf_c$$

Taking  $V = 60$ ,  $R = 5 \text{ k}\Omega$ ,  $C = 50 \text{ pF}$ , and  $f_c = 150 \text{ kc/s}$ ,  $V_o$  (which is the z.f. output across  $R$ ) is 2.25 volts.

It follows that the r.m.s. audio voltage with deviation  $f_d$  is

$$V_{rms} = \frac{VRCf_d}{\sqrt{2}}$$

so with the values given and 75 kc/s deviation it would be 0.8 volt. This compares with 0.17 volt for  $R = 1 \text{ k}\Omega$ ,  $C = 40 \text{ pF}$  and  $V = 80$ ; an advantage of 13.5 dB.

It is convenient to have a  $V_o$  of several volts, for operating a tuning indicator and/or automatic frequency correction. The output being proportional to  $V$ , which is roughly proportional to  $V_b$  within practical limits,  $V_o$  can be matched by a point on a potential divider across  $V_b$ . Any difference between  $V_o$  and the potential of this point will therefore be due to a change in  $f_c$ , the carrier frequency. By adjusting the frequency-changer oscillator—manually or automatically—to bring the potential difference to zero, correct tuning is ensured.

Incidentally, the fact that the output depends on  $V_b$  points to the need for good smoothing in the supply system, because residual hum there would be reproduced in the output.

Next, there are the questions of whether to run the screen grid at a lower potential than  $V_b$ , and how much cathode resistance to use, if any. The many measurements that have been made can be summarized by saying that neither has much influence on performance and current taken under working conditions—i.e., with sufficient signal to cause limiting—but that  $R_{g2}$  and  $R_k$  both reduce  $I_a$  and  $I_{g2}$  considerably when there is little or no signal. By a suitable choice of  $R_k$ , the total current ( $I_k = I_a + I_{g2}$ ) can be kept fairly constant for all signal amplitudes. Fig. 8 shows the results with  $V_b = 120$ ,  $R = R_a = 4.7 \text{ k}\Omega$ ,  $R_{g2} = 10 \text{ k}\Omega$ , and  $R_k = 250 \Omega$ . Note that output is substantially constant for all signal input voltages above 1.5 r.m.s. Similar constancy of  $I_k$  was obtained, and about 5% greater output, with no  $R_{g2}$  and  $R_k = 470 \Omega$ , but the minimum signal input for limiting was raised about 25%.

These results refer to a carrier frequency of 200 kc/s, which is within the reasonably linear range. It is obviously desirable for this range to be considerably wider than the f.m. deviation, in order that great precision and constancy of tuning is not necessary to ensure a low level of distortion. While this was being investigated it became clear that when the signal amplitude was large the ratio of positive to negative epochs in the cycle was excessive and was the first cause of non-linearity at the high-frequency end. The optimum ratio is given by the ratio of the time constants during the positive and negative pulses, which is  $(R_a + R):R$ , or 2:1 in the circuit under consideration. Inserting a 4.7 kΩ resistor in series with the grid of the limiter valve enables a wider frequency range to be obtained at large signal amplitudes. This was included for the plotting of Fig. 8. Fig. 9 shows a recommended practical circuit, following closely the foregoing lines.

Although the useful range of signal amplitude is very wide, 5-20 volts is a suitable order of magnitude.

Linearity is so good, even with the circuit values shown, chosen more for output level than for extreme linearity, that it is not at all easy to measure the distortion. In the absence of a f.m. signal generator modulated  $\pm 75$  kc/s with less than 0.1% total harmonic distortion, the z.f. output voltage ( $V_o$ ) was plotted against frequency by a method designed to exclude voltmeter error, and the curve of departure from linearity (Fig. 10) analysed in two different ways to determine the harmonic distortion at 100% modulation ( $\pm 75$  kc/s). One way was by measuring the vertical differences at selected points between the curve and a straight line and calculating the percentage harmonics from them as described in *Radio Laboratory Handbook*, 6th edition, p. 302. The other was to devise an equation giving a curve close to that of Fig. 10 and calculate the outputs at fundamental and harmonic frequencies for various values of  $f_c$  when  $f = f_c + 75 \cos \omega t$ . The results of these two methods agreed well, and Fig. 11 shows percentage second harmonic as a function of the carrier frequency  $f_c$ . Third harmonic is of the order of 0.1%, and higher harmonics negligibly small.

If the lowest allowable instantaneous frequency to keep well clear of the highest modulation frequency is taken as 25 kc/s, this puts the lower limit of  $f_c$  at 100 kc/s, at which the second harmonic is barely 0.2%. The designed  $f_c$  is 150 kc/s, but Fig. 11 shows that this can be considerably exceeded before distortion is as great as with other types of discriminator at their very best. And whereas these other discriminators can very easily fall much below their best, even if they were sufficiently well adjusted in the first place ever to have attained it, the counter discriminator can hardly give bad linearity, short of gross errors in component values. And whereas conventional discriminators have modulation characteristic curves with comparatively sharp bends at both ends, capable of giving large amounts of the most objectionable kinds of distortion if traversed, the counter discriminator (once the audibly obvious clash of i.f. with a.f. has been cleared) has a wide range of adjustment within which distortion consists almost exclusively of a small percentage of second-order, which is relatively innocuous. It should be

remembered that Fig. 10 refers to 100% modulation, and at the lower depths that prevail nearly all the time the distortion is far lower still. In other words, it is probably fair to say that discriminator distortion is negligible, even by high-fidelity standards. But if anyone is really fussy, he can reduce what distortion there is as much as he likes, by reducing the time constant.

This ordinarily means reducing output in proportion, but an interesting possibility is the use of a cathode follower between the limiter and discriminator proper. This is actually shown in a description of a receiver to which the writer's attention was drawn after the work described here had been done.\* This receiver was for rather special duties, using a 1-Mc/s carrier modulated up to 150 kc/s at  $\pm 250$  kc/s deviation, and required as much as 0.1 V signal at the input to six limiter stages! Another receiver†, this time for broadcast transmissions, was also designed for a comparatively high i.f. (500 kc/s) with the object of rendering tuning non-critical, and uses the same kind of double-triode coupled-cathode limiter stages, four in number, with 2.5 mV input. The same article suggested the use of the double superheterodyne principle for achieving a high sensitivity in a receiver using a counter discriminator.

What appears to be the first description of the counter discriminator‡ made use of it for measuring distortion elsewhere, and therefore had to be virtually distortionless itself; its z.f. output/frequency characteristic is claimed to have departed less than 0.02% from perfect linearity from 50 to 250 kc/s. For the purpose in view, sensitivity was unnecessary, and in fact the 40 Mc/s input to the complete receiver was at the level of 1 to 25 volts!

As mentioned at the start, however, the great advantages of the counter discriminator can be obtained in a simple and practical receiver for broadcast reception, and in a later article it is hoped to give details of this.

\*"Counter-Circuit Multiplex Receiver," by Vallarino, Snow and Greenwald, *Electronics*, July 1953, p. 178.

†"Mobile F-M Broadcast Receiver Design," by K. Onder, *Electronics*, May 1954, p. 130.

‡"Generation and Detection of Frequency-Modulated Waves," by Seeley, Kimball and Barco, *R.C.A. Review*, Vol. 6 (1942), p. 269.

## SHORT-WAVE CONDITIONS

### Predictions for April

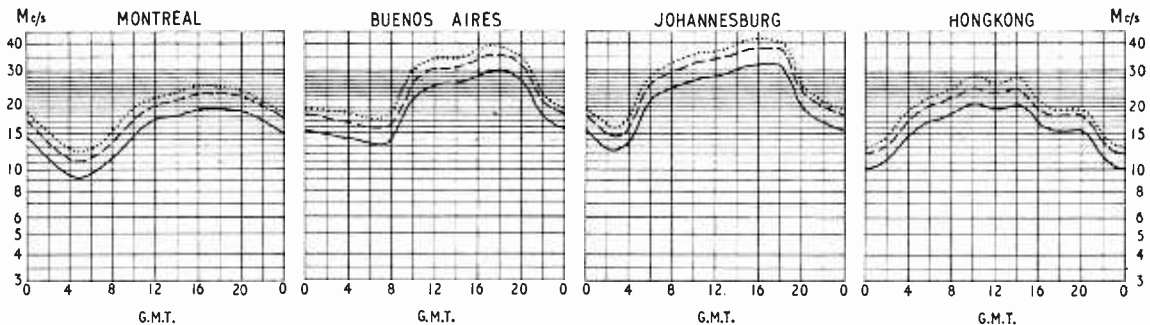

THE full-line curves given here indicate the highest frequencies likely to be usable at any time of the day or night for reliable communications over four long-distance paths from this country during April.

Broken-line curves give the highest frequencies that will sustain a partial service throughout the same period.

- ..... FREQUENCY BELOW WHICH COMMUNICATION SHOULD BE POSSIBLE FOR 25% OF THE TOTAL TIME
- PREDICTED AVERAGE MAXIMUM USABLE FREQUENCY
- FREQUENCY BELOW WHICH COMMUNICATION SHOULD BE POSSIBLE ON ALL UNDISTURBED DAYS

# Television Society's Exhibition

**I**NSTEAD of being an evening affair only, this year's exhibition was held on three consecutive days, March 6-8, mainly during the daytime. The longer hours so spread out visitors that it was much easier to see the exhibits, and the change has been a great improvement. In its new home at the Royal Hotel, Woburn Place, too, more space was available.

Several exhibits dealt with the transient-response testing of television receivers. G.E.C. showed apparatus generating a sine-squared pulse of  $0.2 \mu\text{sec}$  duration with a repetition frequency of 70 kc/s. The receiver output is displayed on a c.r. tube and the effects of receiver bandwidth on its shape are reflected in the curve traced upon the tube screen. The characteristic broadening of the pulse by too narrow a bandwidth, and the ringing following the pulse caused by unsuitable phase characteristics, were well in evidence in the demonstration.

Ferguson showed simplified transient test apparatus for use in production testing. A square-wave modulation of the r.f. signal is used and the receiver output is applied directly to the Y plates of a c.r. tube. The timebase voltage for the X plates is obtained by filtering the square wave to obtain its sinusoidal fundamental. A switched delay line enables the relative timing of the two to be varied in steps of  $0.05 \mu\text{sec}$ .

More in the field of measurement than testing is the Leland Group-Delay measuring set, Model 98, Mark II. This can be used for any transmission system operating in the 50-70-Mc/s band. It can be used to measure group delays of up to  $200 \text{ m}\mu\text{sec}$  with an accuracy of  $\pm 0.5 \text{ m}\mu\text{sec}$ , and the amplitude response from zero to 20 dB. The apparatus has an oscillator sweeping from 50 Mc/s to 70 Mc/s with a repetition rate of 50 c/s. It is frequency modulated at 1 Mc/s with a deviation of 0.5 Mc/s. After passing through the network under test, and being delayed by it, this signal is compared with the original 1-Mc/s modulation. From the comparator, an output at 1 Mc/s, amplitude-modulated in accordance with the delay, is obtained. After demodulation, this provides a voltage proportional to the group delay and is applied to the Y plates of a c.r. tube, to the X plates of which the 50-c/s sweep is applied. The group-delay characteristic is thus displayed in much the same way as the more usual equipment depicts the amplitude-response characteristic. The apparatus can also produce such an amplitude characteristic and marker "pips" are provided.

A wide range of foreign, and some British, measuring apparatus was shown by Livingstone Laboratories. Among this, the Heinz Gunther Neuwirth f.m. signal generator is noteworthy in having a range of 19-230 Mc/s of fundamental frequencies; there is an i.f. range covering 9.5-12 Mc/s operating on the b.f.o. principle. The maximum deviation is 110-kc/s and amplitude

modulation can be applied from an external source simultaneously with the f.m.

A French television pattern generator, the S.I.D.E.R., produces a waveform in accordance with the 625-line C.C.I.R. standard. The pattern includes a series of 5-Mc/s bars.

A compact direct-reading frequency-meter by Gertsch Products of Los Angeles covers 20-1,000 Mc/s and an accuracy of one part in 100,000 is claimed.

In the serviceman's category is the Avo signal-generator Type III, which covers 150 kc/s to 220 Mc/s. A prototype of the same firm's T.F.M. was also shown; this has one f.m. band in addition to a wide coverage with a.m.

Cossor showed the well-known Telecheck, covering Bands I and III, and had a new oscilloscope, Model 1058, with a d.c.-coupled signal amplifier having an upper limit of response of 6 Mc/s. It has a 4-in. tube with post-deflection acceleration of the electron beam.

There were a good many oscilloscopes and associated equipment on view. Among the latter, the Mullard television line selector can be used with any triggered oscilloscope. It enables any line of a television picture to be selected at will and displayed on the oscilloscope. In addition, at 50 c/s, both odd and even frames can be displayed superimposed upon each other so that differences between them can readily be seen.

Several picture monitors were on view. The Cintel has a 14-in. tube and especial care has been taken in the design of the focus and deflector coils in order to secure good focus over the whole picture area. The associated amplifier has a response flat within  $\pm 0.5 \text{ dB}$  up to 3 Mc/s and is phase corrected. The Murphy Radio monitor includes a two-band receiver. It has a 9-in. tube with a wideband video amplifier arranged to accept an input either from the internal receiver or from any external source.

Ediswan demonstrated equipment for determining the optimum grading of turns in a deflector coil. The assembly is made with a normal frame winding and a line coil split into two parts. All windings are fed at 50 c/s and the grid of the tube is pulsed



Left: Avo Type III signal generator.

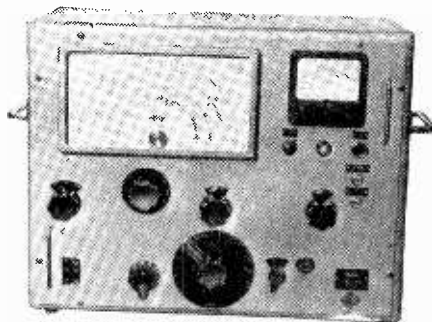

H. G. Neuwirth f.m. signal generator.



20th Century Electronics series D6 square-face tube with two guns.

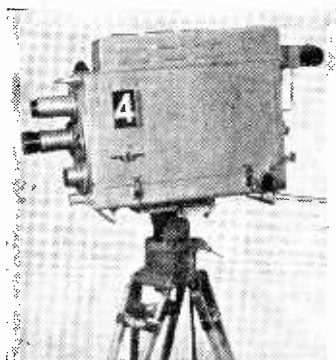

New Emitron camera with electronic viewfinder.

Rear view of Leland meter showing the movement in one corner at the back of the scale.

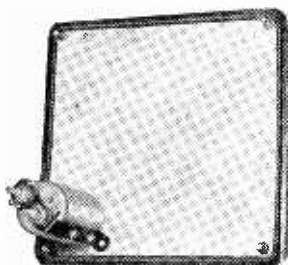

at the peak of the deflecting wave so that only a spot appears on the screen. This can be moved to any part of the screen by adjusting the currents, and changes in its shape are at once evident. A control enables the ratio of the currents in the two parts of the line coil to be adjusted and, by determining the optimum ratio, the proper grading of turns in the winding can be deduced.

Ediswan also showed the use of an electrostatic lens between the mask and the screen of a colour c.r. tube. By giving some focusing action, it improves efficiency by permitting the use of larger holes in the mask and it also improves the deflection sensitivity.

The large and the small in c.r. tubes was in evidence here also. The new 24-in. tube for operation at 20 kV was shown, as well as a 9-in. with tetrode gun and ion trap.

20th Century Electronics showed their well-known range of precision oscilloscope tubes with up to four guns. Some new types are built with square and rectangular faces in order to reduce the space. Mumetal screens for tubes of these new shapes were displayed by T.M.C.

The G.E.C. exhibit took the form of a series of demonstrations of an experimental nature. One showed the use of a transistor as a sync separator in a television receiver. Another illustrated a special circuit designed to keep the black level of a television picture at a fixed value despite variations in

the e.h.t. supply. It does this by appropriately changing the d.c. gain of the amplifier. It includes a gated a.g.c. system.

The printed circuit is gaining in popularity and T.C.C. exhibited many examples of it in the form of i.f. filters and aerial crossover networks. It is being applied also to television tuners where the rigid and consistent placing of connections is very helpful in enabling consistency of performance to be secured. It is even being applied to aerials! T.C.C. showed some Band III V-dipoles for building into a receiver; in one example, the dimensions were reduced by centre loading, the "coil" for this being printed with the aerial "rod".

Belling-Lee displayed a rotating aerial mechanism with electrical remote control of its orientation. It can be used, and was so demonstrated, in continuous rotation in plotting the directional characteristics of an aerial. A calibrated v.h.f. receiver for field-strength measurement was also shown.

Another instrument of this character is the J.S.F. field-strength meter shown by Fielden. It is claimed to have an accuracy of  $\pm 10\%$  on Band I and  $\pm 25\%$  on Band III; it is intended for checking aerial performance.

An unusual form of meter movement for pointer instruments was to be found on the Leland stand. It is enclosed in a cylindrical case and is of the Brion Leroux type with the moving coil *outside* the field magnet. It is very compact and the same basic movement is used for all scale sizes.

In addition to a range of measuring apparatus, E.M.I. were showing a new television camera with control desk and associated equipment. The camera is built around a new Emitron tube which is claimed to provide a superior performance. It is of the "cathode potential stabilized" type.

A newcomer in the television camera field is Peto Scott, whose camera was demonstrated by Livingstone Laboratories on a test card. The tube is of the photo-conductive type and results in a very compact and light camera.

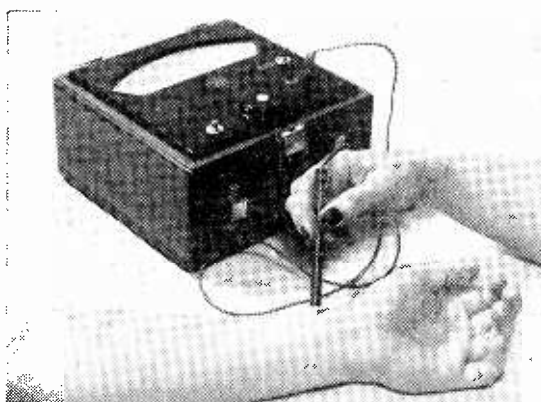

A THERMISTOR probe, a bridge circuit and a pointer indicating instrument are the essential parts of this new medical thermometer designed for measuring small changes in skin temperature. Made by the Vibro-Ceramics Corporation of Metuchen, New Jersey, U.S.A., it is said to be instantaneous in operation and to be particularly suitable for measuring capillary temperature, which gives a great deal of information about the circulatory system.



# Phase Shift and Sound Quality

Experiments to Determine How Much Can Be Tolerated

By J. MOIR\*, M.I.E.E.

**M**ANY recent amplifier designs have included among their claims to fame in the high-quality sound reproducer field, such statements as "zero phase shift down to 10 c/s or up to 100 kc/s." It is proposed in this article to discuss briefly the meaning of phase shift, to consider the circuit elements responsible and then to examine its effect on the quality of sound reproduced by loudspeakers, to see whether figures for phase shift are worth including in an amplifier specification.

In any circuit that includes a reactive element such as a capacitor or an inductor the alternating current will not reach its maximum value at exactly the same instant as the voltage reaches a maximum. If the circuit includes inductance and resistance only, the current lags, as indicated by the curves of Fig. 1; but if the circuit is composed of capacitance and resistance the current will lead the voltage under steady-state conditions.

The time difference between voltage and current maxima is a significant indication of circuit conditions, but it has become conventional to indicate the time difference not in seconds but as a fraction of the time (period) of one complete cycle at the frequency being considered. Thus the phase shift is one quarter cycle when the circuit is composed entirely of inductance (Fig. 1) or capacitance. Alternatively the difference may be expressed in degrees, and a quarter-cycle phase shift then corresponds to a 90° phase shift. There are other methods of specifying the time difference, but as amplifier designers appear to favour the use of degrees this convention will be generally used in the ensuing discussion. The reasons for the displacement in time of the voltage and current maxima will not be discussed here, our present concern being the final acoustic effects.

The phase shift introduced by a simple circuit of one reactive element and one resistor can never exceed one quarter cycle or ninety degrees, and can only reach this value when the resistor is reduced to zero. The phase difference between voltage and current for a simple combination of resistance and capacitance is plotted in Fig. 2(a) as a function of the ratio of circuit resistance to circuit re-

actance. This dependence on circuit reactance makes any particular pair of components introduce a phase shift which varies with frequency in exactly the manner shown in Fig. 2(a) if  $f_0/f$  is substituted for  $X_c/R$  and  $f/f_0$  for  $R/X_c$ ,  $f$  being the frequency under consideration and  $f_0$  the frequency at which  $X_c=R$ .

These simple circuits of Fig. 2(b) will be recog-

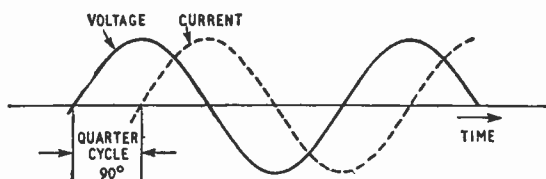
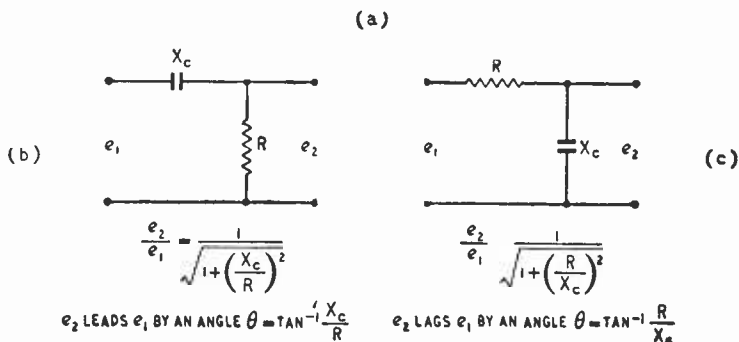
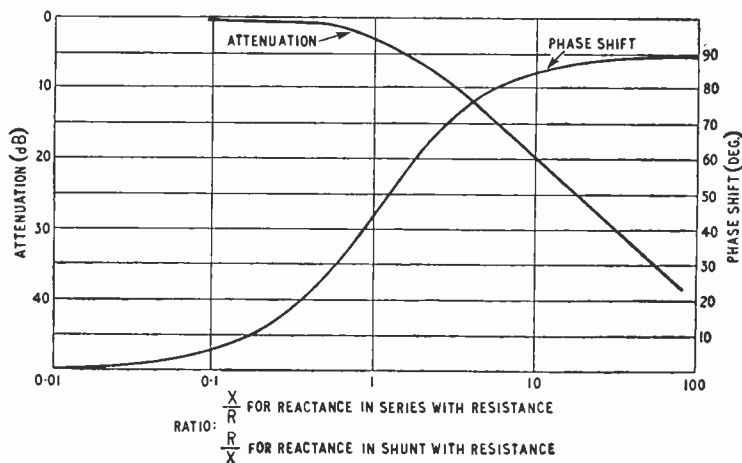

Fig. 1. Conditions in a reactive circuit with voltage and current waves displaced by 90° or one quarter cycle.

Below: Fig. 2. (a) Phase shift and attenuation introduced by single combinations of reactance and resistance such as those at (b) and (c).



\* Electronics Engineering Dept., British Thomson-Houston Co., Ltd.

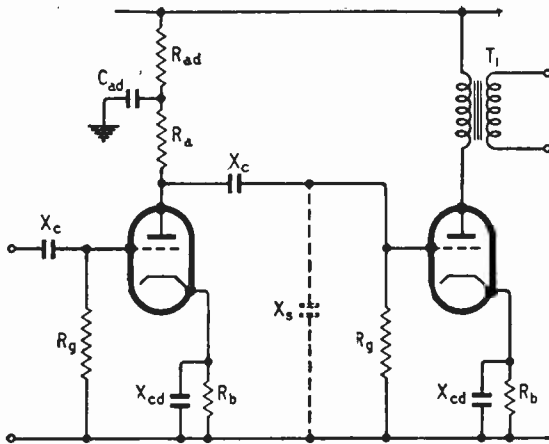

Fig. 3. Elementary amplifier showing sources of phase shift.

$X_c$ and $R_g$	Output voltage leads input voltage at low frequency
$C_{ad}$	" " " " " " " " " " " "
$R_{ad}$	" " " " " " " " " " " "
$R_b$	" " " " " " " " " " " "
$X_{cd}$	" " " " " " " " " " " "
$X_c$	" " " " " " " " " " " "
$R_a$	" " " " " " " " " " " "
$T_1$	" " " " " " " " " " " "

nized as those used as interstage coupling circuits in RC amplifiers (b) being the grid coupling capacitor and resistor and (c) the anode load resistor with the effective shunt capacitance in parallel with it.

Iron cored devices such as input and output transformers introduce phase shifts at low frequencies of the same order as an RC stage, but may introduce more rapid changes of phase in the region between 30 and 100 kc/s where resonance between the leakage reactance and any stray capacitance can (and usually does) occur.

The circuit diagram of a simple amplifier is reproduced in Fig. 3 showing the circuits responsible for phase shift with an indication of the direction in which the phase is shifted. The overall phase shift is approximately the algebraic sum of the phase shifts of the individual circuits. Application of negative feedback reduces phase shift in the same ratio that it reduces other distortions, a typical result for a high-quality amplifier being shown in Fig. 4.

Though phase shift has been discussed in terms of the difference in time between voltage and current maxima it will be appreciated that this is also the phase difference between the input and output voltages in a circuit such as Fig. 2(b), for the output voltage is in phase with the current in the resistor.

The change of phase with frequency appears to be fairly rapid, even with the simple circuits, but basically it is the change in the time of transmission with frequency that introduces waveform distortion. Further investigation

shows that the time of transmission between input and output terminals of a network such as Fig. 2(b) is fairly constant at all frequencies at which the circuit attenuation is low. A time of transmission that does not vary with frequency implies a phase-shift/frequency characteristic in which the phase shift is proportional to frequency and not a phase shift that is constant at all frequencies.†

It takes very little consideration to decide that the waveform of a complex wave composed of many frequencies will be drastically distorted in passing through any device in which the time of transmission varies for each of the component frequencies. An example is illustrated in Fig. 5, the output signal on the right, bearing very little resemblance to the square-wave input signal, though all the distortion shown is the result of phase shift and not the result of any frequency-dependent attenuation.

It will be clear that there is considerable difficulty in designing an amplifier (or any other piece of equipment) in which the phase shifts are reduced to zero at all frequencies. If it is considered that waveform distortion must be avoided there are four possible solutions. The first is merely to avoid phase shift completely, a council of perfection. The second is to avoid phase shift within the audio-frequency band of say, 30 to 10,000 c/s. The third solution is the use of a phase/frequency characteristic in which the phase shift in degrees is linearly proportional to frequency, for if this is done all the frequency components are delayed by the same time interval. It is generally of little consequence if a complex signal takes even several milliseconds to pass through an amplifier, provided that all the components take the same time.

The final solution is separately to determine the maximum amount of phase shift that can be allowed before the result is aurally detectable, and then to ensure that the actual phase shift introduced by the system is below this limit. In an extensive audio network this is the only practical solution. The "just detectable" phase shift is a problem that has been the subject of many investigations, but the most authoritative works known to the writer are due to van der Pol of the Philips Research Laboratory and

Fig. 4. Typical phase-shift characteristics of a high-quality domestic amplifier.

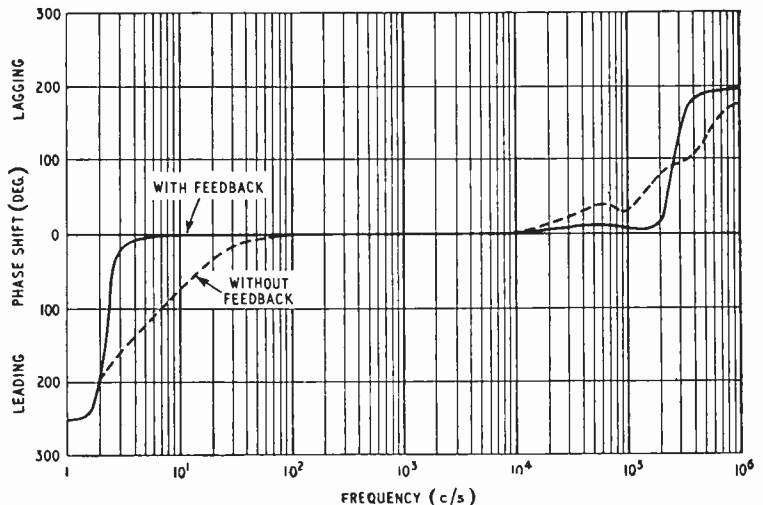

† This aspect is developed by "Cathode Ray," whose contribution this month (p. 188) happens to include a discussion of the basic relationships between phase/frequency distortion and amplitude/frequency distortion.—Editor.

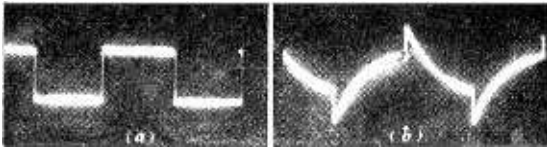

Fig. 5. Effect of phase distortion on a square-wave signal after passing through a reactive network in which there is no variation of attenuation with frequency. Repetition rate, 300 per sec.

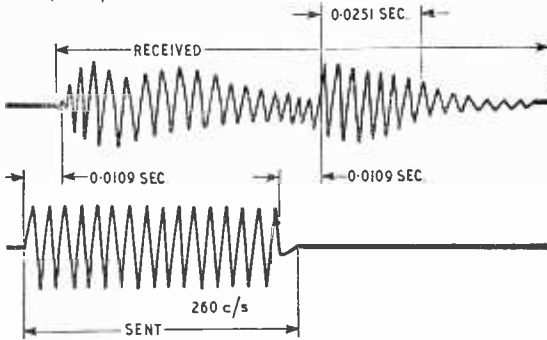

Fig. 6. Distortion of tone pulse due to phase shift.

to Steinberg and Lane of the Bell Telephone Laboratories.

Van der Pol made a limited investigation using a special circuit that allowed him to change the phase of the higher harmonics of a complex wave relative to the fundamental by any amount up to  $360^\circ$ . He noted that any phase shift within this limit introduced no effects detectable when listening to speech.

Steinberg and Lane used an experimental technique that permitted much greater amounts of phase shift to be introduced into the reproducer system. Low-pass or high-pass filters of the normal ladder type introduce appreciable amounts of phase shift near the ends of the transmitted range. Filters of this kind may be added in series to produce any desired amount of shift at any point in the frequency range. The "just detectable" amount of phase shift proved to be so large that it is more convenient and indeed more indicative of the mechanism to express the shift in milliseconds.

To produce effects detectable on speech it was found necessary to shift the frequency components in the 5-8 kc/s band by about 8 milliseconds relative to the 1 kc/s components. Frequency components in the 50-100 c/s region had to be shifted by as much as 70 milliseconds before the effect was detectable. These time differences correspond to a relative phase shift of 64 complete cycles or 23,000 degrees at 8 kc/s and to a shift of 7 complete cycles or 2,520 degrees at 100 c/s.

Delays of this order are recognized as separate hollow ringing echoes, an effect often heard on long telephone lines and somewhat akin to acoustic reverberation.

The electrical effects can be demonstrated by injecting short pulses of tone into the equipment under test. The transmitted and a typical received signal are shown in Fig 6 (based on Fig. 10, p. 503, *B.S.T.J.*, Vol. 9, 1930) for a filter having a time delay of 0.01 seconds, and it will be seen that both head and tail of the transmitted pulse are badly distorted, the pulse being stretched until the received pulse is almost twice as long as the transmitted pulse.

Reference to Fig. 4 will remind the reader that an ordinary amplifier of the type likely to be used by the high-quality enthusiast is more likely to have phase shifts of a few degrees, quite innocuous in comparison with the phase shifts found necessary to produce audible distortion.

To the best of the writer's knowledge these results remain as authoritative, no subsequent investigation having thrown the slightest suspicion on the results of van der Pol, Lane and Steinberg.

It is commonly stated that though phase shift may not have much effect on the quality of steady tones it does have a much greater effect on the quality of transients. Steinberg did in fact comment upon this point, noting that phase distortion was much more objectionable on speech than on music. However, the minimum detectable phase shifts quoted earlier are the figures obtained from tests on speech. Though transient in nature, speech may not represent the ultimate in this respect so that to gain some personal experience tests were instituted using square waves.

A high-quality reproducer system was set up employing amplifiers capable of passing square waves without perceptible waveform distortion when the output signal at the speaker terminals was viewed on an oscilloscope. Loudspeakers may be the weak link, but those used were representative of the highest quality currently available, several different types having been employed at different times.

The input signal was the square wave shown in Fig. 5, lattice all-pass filters being employed to introduce phase shift without any frequency-dependent attenuation. The result of introducing phase shift

Fig. 7. The lower traces are the acoustic waveforms at points on or near the axis and at distances not more than 3ft from the diaphragm of a loudspeaker to which a square voltage wave has been applied. Repetition rate 900 per sec.

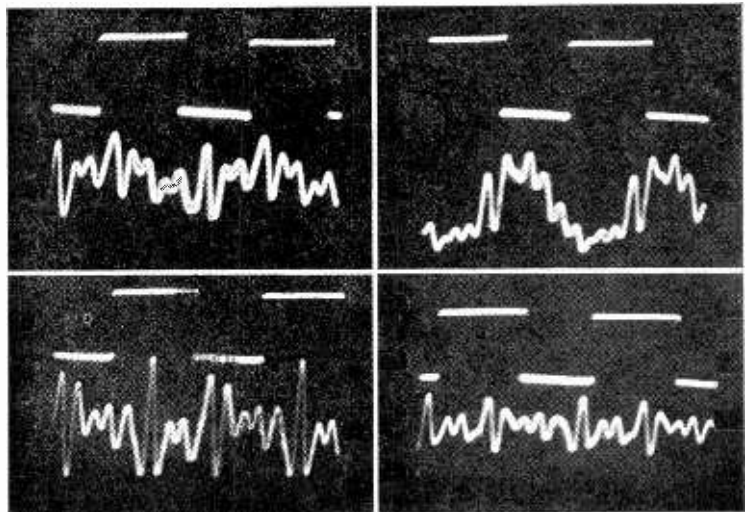

was to convert the waveform of Fig. 5(a) into that of Fig. 5(b) but even this drastic change could not be detected by any member of an experienced listening crew. The equipment has subsequently been used as a demonstration at several lectures, but to date, no listener has ever claimed to be able to detect the difference between the two waves.

This cannot be claimed as an absolutely conclusive test for there are an infinite variety of transient waveforms and it will always be impossible to claim that all have been tested; but taken in conjunction with other results it does suggest that phase shift is certainly not of great importance and may not be of any importance. This point of view has been confirmed in private communication with other workers on the subject.

When the results of laboratory tests appear to contradict common sense it is always worth looking round for confirmation or contradiction from everyday experience. A little consideration of the acoustic conditions in any concert hall will suggest that it is perhaps providential that our sensitivity to phase shift is low.

Sound from any source, original or a reproduction, reaches the listener first by the direct and shortest path and then by successive reflections along paths of increasing length. At listening positions only a few inches apart the acoustic pressure pattern in space varies enormously as different reflection paths of varying length become of predominating importance, and yet the sound quality remains unaltered. This is illustrated by the oscillograms of Fig. 7 indicating the changes in acoustic waveform at points a foot or so apart when a square wave (voltage) is impressed on the loudspeaker terminals. At some points the acoustic pressure waveform approximates that of the electrical signal but at other points there is little resemblance to a square wave. All the check points were on or close to the speaker axis and not more than three feet from the speaker.

Current loudspeaker designs provide another simple indication of the unimportance of phase shift in small amounts. In the sound reproducer field many of the loudspeakers having the highest reputation consist of units radiating the high frequency components either directly from the front of the cone or via a short straight horn, while the low frequency components below perhaps 500 c/s are radiated from the rear of the cone through a long folded horn. The difference in path length traversed by the low and high frequency components may amount to 5-8 feet (5-8 milliseconds, about 360 degrees at 150 c/s) and yet loudspeakers of this type such as the Lowther, Tannoy and Klipschorn have an acknowledged reputation for quality of reproduction.

Quite clearly the evidence suggests that phase shift does not have the importance usually attached to it by the high quality enthusiast. The phase shift introduced by any amplifier of normal design is so low in comparison with the minimum detectable phase shift that it is hardly worth considering. A broadcasting or telephone administration operating an extensive interconnection system that might involve 80-100 amplifiers connected in series would, however, have to pay a little more attention to the phase shift introduced by the individual amplifiers in order to keep the total shift below the minimum detectable figure. Even in this instance the audible effects of phase shift are usually due to shifts introduced by filters or by the line itself near the ends

of the transmitted frequency band and are not due to the amplifiers.

This discussion suggests that the phase shift introduced by a domestic amplifier is of little consequence as an indication of the quality of reproduction and is not really worth quoting. Phase shift is of importance when considering the stability of an amplifier with feedback but this is an entirely different matter.

It is perhaps an indication of the omnipotence of nature that she has developed a hearing system that is insensitive to phase shift.

Thanks are due to Chapman and Hall for permission to use the diagrams taken from the writer's book "High Quality Sound Reproduction" to be published shortly.

## REFERENCES

"A New Transformation in AC Theory with an Application to the Theory of Audition," Balh van der Pol, *Proc. I.R.E.* Vol. 18, February 1930.

"Phase Distortion in Telephone Apparatus," C. E. Lane, *B.S.T.J.*, Vol. 9, July 1930.

"Effects of Phase Distortion on Telephone Quality," J. C. Steinberg, *B.S.T.J.*, Vol. 9, July 1930.

"Motion Picture Sound Engineering," Chapter 13, (Chapman and Hall).

## BOOKS RECEIVED

**The Services Textbook of Radio: Vol. 3.—Electronics** by J. Thomson, M.A., D.Sc., F.Inst.P., M.I.E.E. Edited by the technical staff of *Wireless World*. One of a series of seven volumes issued jointly by the Admiralty, the War Office and the Air Ministry for the instruction of beginners and as a standard work of reference for technicians in civil life as well as in the Services. Deals primarily with the thermionic valve in all its forms and includes chapters on semi-conductors, photo-electric devices, electron optics and cathode-ray tubes. Pp. 259+ix; Figs. 218. Price 12s 6d. Her Majesty's Stationery Office, York House, Kingsway, London, W.C.2.

**Fundamentals of Television Engineering** by Glenn M. Glasford. Comprehensive analysis of television system design problems from the camera tube to the receiver display, in which alternative solutions are considered from both the theoretical and the technically realizable standpoint. Colour and monochrome are dealt with concurrently and circuit analysis makes full use of the transform calculus. Pp. 642+xiv; Figs. 567. Price 71s 6d. McGraw Hill Publishing Company, Ltd., 95, Farringdon Street, London, E.C.4.

**Metal Transfer between Palladium and Silver Contacts at Low Inductances** by J. Riddlestone, B.A. E.R.A. Technical Report U/T133 on the nature and extent of erosion and accretion in contacts breaking currents from 3 to 15A at 6V in circuits with inductance between 0.07 and 96 $\mu$ H. Pp. 21; Figs. 12. Price 12s 10d by post. The Electrical Research Association, Thorncroft Manor, Dorking Road, Leatherhead, Surrey.

**Electrical Who's Who, 1956-57.** Brief biographies of leading members of the professional and industrial branches of the industry, including telecommunications, together with lists classified under the titles of firms and organizations. Pp. 454. Price 21s. Electrical Review Publications, Ltd., Dorset House, Stamford Street, London, S.E.1.

**British Plastics Year Book, 1956.** Classified guide to products and manufacturers giving addresses of 4,000 firms in 50 countries. Includes buyers' guide to materials and plant, a review of recent plastics patents, a glossary of terms and lists of proprietary names, trade associations, etc. Pp. 740. Price 35s. Iliffe and Sons, Ltd., Dorset House, Stamford Street, London, S.E.1.

# TELEVISION AT U.H.F.

## PROPAGATION PROBLEMS IN BANDS IV AND V

THE success of the future expansion of television broadcasting in this country depends to a marked extent upon the ability to exploit the internationally allocated Bands IV and V, covering the frequency ranges of 470 to 585 and 610 to 960 Mc/s, respectively. Apart from the problems of developing high-power transmitters and sensitive noise-free receivers to operate on these frequencies, it is most important to have a clear and detailed knowledge of the propagation of the radio waves involved. This propagation will determine, on the one hand, the service areas of the transmitters and, on the other, the possibilities of interference from other stations whether engaged in the same or different services.

In a paper\* read before the Television Society in March, Dr. R. L. Smith-Rose reviewed the present state of knowledge of u.h.f. propagation, particularly in so far as the future possibilities of television services in Bands IV and V are concerned. Dr. Smith-Rose and his collaborators, Dr. J. A. Saxton and J. A. Lane, have already published in *Wireless World*† and elsewhere a good deal on this subject and this material was drawn upon for the lecture. Having dealt in general with the theory of u.h.f. propagation over "smooth earth" and over irregular terrain, the lecturer concluded with some practical results with television transmitters operating in the u.h.f. band.

Some experience in this direction has already been obtained in the United States where a number of experimental television stations operating in the u.h.f. band have been set up during the past few years. Early experiments by the Radio Corporation of America have emphasized that it is important that the transmitting aerial system should be as high as possible above the surrounding terrain. A full-scale investigation has therefore been conducted with station KPTV, at Portland, Oregon, where the main populated area to be served is relatively flat and lies in a valley between two mountain ranges. The transmitting aerial at this station was installed on a ridge to one side of the town and at a height of about 1,000ft above it.

The transmitter operates in the American frequency channel No. 27 (548 to 554 Mc/s). Its output power is one kilowatt fed to a slot aerial installed on top of a 200ft tower. This would give a power gain of 21 in the horizontal plane, but the aerial is mechanically tilted forward about 1 degree towards the populous city area, and it is electrically adjusted to increase the signal radiated in what would otherwise be a "null" in the radiation pattern. The resulting effective radiated power is 16 kW.

Measurements have been made with a mobile receiver of the field strength obtained in four radial directions from this transmitter out to distances of

more than 30 miles. The results calculated on an e.r.p. of 1 kW are reproduced in the diagram on which are drawn curves for the free space radiation (A) and for the median conditions for 50% of locations and 50% of time (B) recommended by the F.C.C. for operation in this frequency channel. It will be seen that the measured values lie reasonably along this median curve although there is a spread among the observed values, particularly at the shorter ranges. Somewhat similar results have been obtained at three other stations at South Bend (Indiana), York (Philadelphia) and Atlantic City (New Jersey) on frequencies which range from 590 to over 700 Mc/s. In all cases, the median curve is followed, but there are conspicuous shadow areas where the field strength may range over  $\pm 10$  dB about this curve.

Field strength contours for the Portland transmitter show a constriction between mountains enclosing the valley, and also the existence of "dead" spots where reception of signals is very difficult indeed; these comprise about 5% of the built-up city and 12% of the whole residential area. However, the transmitter will furnish a good service to 88% of the population in the Portland area, and this could be increased to about 94% by increasing the effective radiated power to between 100 and 200 kW, or about ten times the present value. On this basis it is considered that in such favourable locations the use of u.h.f. for television can compare very well with v.h.f. although it may require ten times as much transmitter power to cover the same area.

Apart from propagation studies, the experience obtained at Portland has provided a good deal of information on the performance of receivers used with the type of aerials to be normally provided for u.h.f. reception. The limit to the reception of good television pictures is set by the noise level of the input circuits of the receiver, this noise being

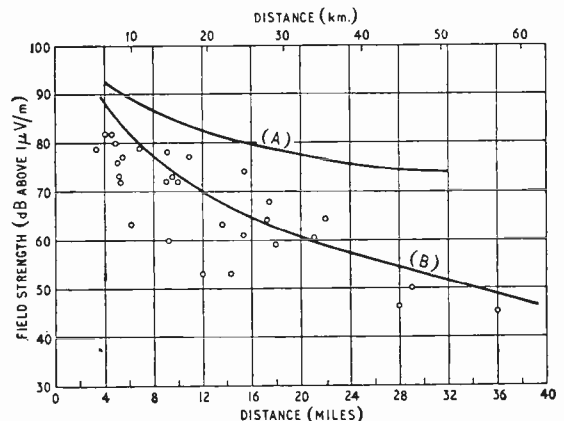

Measured field strength along four radials from transmitter KPTV at Portland, U.S.A.

\* "Radio Wave Propagation and the Problems of Television Bands IV and V."

† *Wireless World*, May and July 1955.

responsible for what is termed "snow" on the screen of the cathode-ray tube. Actual observations showed that under these conditions a good picture was obtained with a field strength of 2mV/m (66dB above 1  $\mu$ V/m); and this would appear to agree favourably with the target which has been set by the F.C.C. at 1.6 mV/m (64 dB above 1  $\mu$ V/m for the class B service). For the first-class or A service, the required signal should be 10 dB greater (74 dB above 1  $\mu$ V/m). It seems likely that in due course these conditions will be met by the use of effective radiated powers well within the limit of 1,000 kW set by the F.C.C.

As a final word of warning, however, Dr. Smith-Rose said there is still much to be learnt about the phenomena of propagation on these higher frequen-

cies. The possibilities of multi-path transmission, in which two or more waves may reach a receiving aerial with resulting complex interference patterns, are likely to add to the difficulties of the so-called "dead" areas of reception. There is also the subject of the effect of varying weather conditions on propagation through the troposphere. In this case, the effects observed are unlikely to be serious at service ranges of 20 to 30 miles; but, as was the case for v.h.f. propagation, a knowledge of these tropospheric effects is essential before plans involving the sharing of frequency channels by stations in different localities are drawn up. These are among the problems requiring further investigation as the development of u.h.f. for television transmission proceeds.

## Manufacturers' Products

### NEW EQUIPMENT AND ACCESSORIES FOR RADIO AND ELECTRONICS

#### Mobile Radio

THE illustration shows the new mobile radio v.h.f. equipment introduced by Murphy Radio. The unit partly withdrawn from its case is the transmitter-receiver chassis of the mobile set, Type MR800, while the larger self-contained set is the Type MR862 for fixed stations. A separate 6- or 12-volt vibrator-type power unit is used for the mobile set as this allows greater flexibility in installation.

Controls on both sets are reduced to a minimum and on the mobile they comprise only an on-off switch (with receive and stand-by positions), volume control and send-receive switch on the microphone or handset. Transmitter and receiver are crystal controlled and can be set up on any single frequency in one of the three bands 60 to 90 Mc/s, 100 to 133 Mc/s or 133 to 174 Mc/s. The receiver is a double super-heterodyne.

The self-contained fixed station set measures 22in  $\times$  11in  $\times$  10in and it employs the same r.f. chassis as the mobile set but modified to provide a slightly larger r.f. power output, muting circuits and remote control equipment. It is a.c. operated. The normal controls comprise volume, on-off switch, muting and meter selection

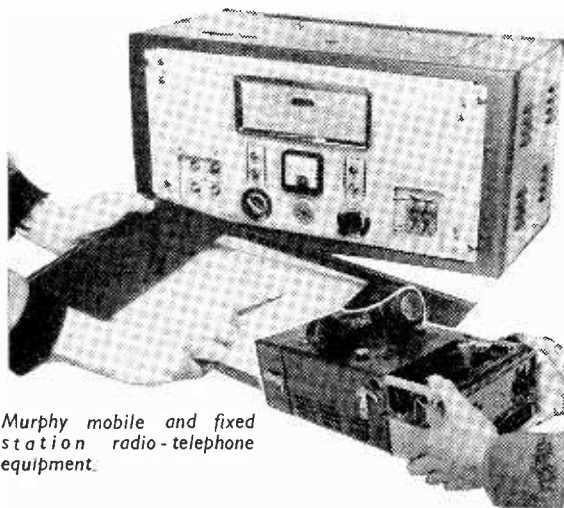

Murphy mobile and fixed station radio-telephone equipment.

switch for monitoring purposes, with the send-receiver switch on the microphone stand (or remote control unit when used). Provision is made for remote control over internal or external G.P.O. lines. In the illustration the front panel surround is removed revealing two sets of subsidiary controls for setting-up and change in frequency. With a suitable transmitting aerial a working range of 15 miles or more is possible.

The makers are Murphy Radio, Ltd., Welwyn Garden City, Herts, and the prices are £85 for the mobile and £150 for the fixed station set.

#### Lightweight Headset

WEIGHING only 7oz, the Type 2566 headsets made by the Industrial Products Division of Amplivox, Ltd., 2, Bentinck Street, London, W.1, are designed to minimize fatigue when worn for long periods. They have in fact been adopted for use in the control towers of airfields under the administration of the Ministry of Transport and Civil Aviation.

Electro-magnetic insert units for the earpieces have acoustically equalized response within  $\pm 3$  dB from 200 c/s to 3,300 c/s. Three types of microphone insert, including a differential noise-cancelling model, are available.

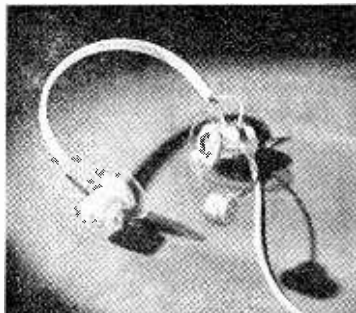

Flexibly mounted Perspex ear discs are a feature of the Amplivox lightweight headset/microphone sets.

#### U.H.F. Communications Receiver

IN the description of the Eddystone 770U receiver on page 118 in our March issue the bandwidth was given as 15 kc/s whereas this is the kc/s-off-resonance figure at the 3-dB points. The corresponding bandwidth is therefore 30 kc/s.

# LETTERS TO THE EDITOR

The Editor does not necessarily endorse the opinions expressed by his correspondents

## Disc Playback Characteristics

THERE have recently appeared an entirely new crop of gramophone recording (playback) characteristic titles:

- (a) R.C.A. "New Orthophonic."
- (b) New A.E.S. (January, 1954).
- (c) R.I.A.A.
- (d) N.A.R.T.B. (June, 1953).
- (e) B.S. 1928:1955.
- (f) C.C.I.R. } Proposed revisions
- (b) I.E.C. } to be confirmed.

All these authorities specify a fine groove characteristic, and they are all identical. Some also specify a coarse groove characteristic and again they are all identical. These two characteristics are now used by nearly all the major manufacturers throughout the world and they may therefore be taken as international standards. All that remains is to standardize the title, preferably in some short form that may be easily fitted around the periphery of a record equalizer selector knob together with the older characteristics.

None of the titles given above is ideal, either because they may not be internationally known or are cumbersome. (Or both; imagine a switch position labelled "British Standard 1928:1955 Fine Groove.") Simplification to "LP" and "78" fails to distinguish between a wide variety of earlier characteristics and does not apparently allow 45-r.p.m. records to be played, not to speak of complications with fine-groove 78-r.p.m. records. Another possible solution is to use the terms "FINE" and "COARSE." The operator of the gramophone will then fall into one of four groups. First, those who know; secondly, those who try to measure the width of the groove with a 12-in rule; thirdly, those who think it refers to the song on the record rather than the groove; and, fourthly, those who do not understand English anyway.

The most logical solution seems to lie in an extension of the Red Triangle, Green Square system (B.S. 1928:1955). This at present may be used on transcription record labels and on pickup heads to indicate fine groove or coarse groove. Used also as an equalizer switch position marking, it forms the basis of a simple unambiguous system, free from language difficulties.

For example, if the record label bears the symbol



(preferably in red), it conveys the following

information:

(a) The recording characteristic used is that recommended for fine groove records in B.S. 1928:1955 or equivalent.

(b) The turntable should revolve at 45 r.p.m.

(c) The pickup head should bear the red triangle symbol (or in the case of turn-over types, be set so that the symbol is visible), i.e., the stylus tip radius should be 0.001in.

(d) The equalizer switch should be set to the red triangle position in order to select the correct playback compensation.

Huntingdon.

JOHN D. COLLINSON.

## Single or Double Sideband?

THE decision to open the Crystal Palace Television station on a vestigial sideband basis was taken, states the B.B.C., after consultation with the G.P.O., the Radio Industry, and the Trade. The viewing public was not apparently consulted.

The arguments against such a decision are:—

1. The change makes a large number of receivers obsolete.

2. The channel space saved is jammed in between two channels in a band allocated exclusively to television and is, therefore, unlikely to be used for anything else.

3. Sentimentally there is a case for retaining for as long as possible (and at least until there are no receivers using both sidebands) the superior performance possible with double sideband operation in this special case of the world's first high-definition television service.

4. The change can be made easily at any time in the future.

The modification necessary to the double sideband receiver is not too difficult but the modification to the upper sideband receiver is extremely difficult, involving as it does a complete new tuning set-up over several stages and the inclusion of two or more sound rejection circuits. In the B.B.C. statement to the Press dated March 8th, 1956, these latter receivers are dealt with as follows.

"In a few cases, some modifications to the receiver may be advisable and there may be some slight loss of detail in the picture." This is a masterpiece of understatement.

In the diagram below the shaded area represents the

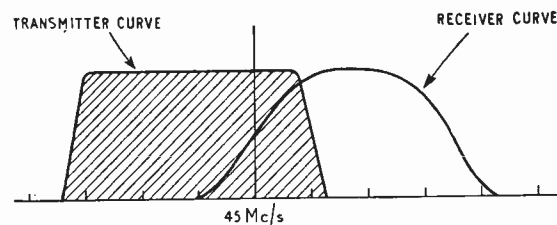

information sent by a vestigial sideband transmitter. The full line curve shows the reception capability of upper sideband receivers. The area under this receiver curve outside the shaded area represents what is described as the slight loss of detail. If such a "slight loss" occurred in apparatus for the B.B.C. instead of for the public, the B.B.C. would undoubtedly describe the loss of information as serious and unacceptable.

In a classic paper by Sir Noel Ashbridge in 1951\*, on the British Television Service, he says "Consideration has been given to modifying the characteristics of the Alexandra Palace transmitter so that this, too, could radiate only one vision sideband. At the time of consideration the number of receiving sets in use was of the order of 60,000; it was decided that it would be unfair to the owners of these sets to change the characteristics of transmission."

These sentiments are admirable but it would seem that the same situation today has not received the same consideration.

"LAMBDA."

\* Proceedings of the Joint Engineering Conference, 1951, Part II, page 491.

## Ionospheric Scattering at V.H.F.

DR. SAXTON'S article in your January issue is timely—if disappointing. As would be expected from the author, his treatment of the subject is scientific and logical. No one will quarrel with this approach, except perhaps that enough acknowledgment is not given to the great effort put into the study and development of scatter techniques in North America in the last few years.

As you read the article, you get a growing impression

that ionospheric scatter is still largely experimental, and the final section on "Application to Communications" damns the whole subject with such phrases as "unlikely to be satisfactory," or when dealing with telephony—"impracticable transmitter power." It ends with the inference that when an aurora occurs a scatter link becomes "practically impossible"—a generalization which is almost certain to prove untrue.

The Proceedings of the recent Convention of the U.S. Institute of Radio Engineers on scatter give an almost overwhelming volume of information on the subject; in particular an account is given of six circuits in America, Greenland and the Azores which have been operated experimentally using ionospheric scatter over a considerable period. One terminal situated at Sondre Stromfjord, in Greenland (in a region of high aurora activity), appears to have worked Goose Bay satisfactorily over a period of 3½ years. There are, of course, no published figures of the performance of the operational circuits subsequently established, but the fact is that the U.S. Forces *have* decided to use ionospheric scatter operationally and they will clearly not be satisfied with the very few channels and frequent interruptions that Dr. Saxton expects.

Furthermore, a number of U.S. and Canadian manufacturers and consultants are prepared both to erect ionospheric and tropospheric scatter links or to work out the parameters for the customer who is prepared to do the job himself. They are quick to point out the advantages of such links, such as their reliability and the elimination of frequency changing. In the case of tropospheric scatter very large bandwidths can be handled over short distances.

V.H.F. scatter is not the answer to all communications headaches, and the ionospheric variety has a somewhat limited field of application. However, I do urge that it is time we stopped looking on scatter circuits as a difficult experimental feat; they are already operational, and we in this country are in danger of being left farther and farther behind.

London, W.1.

C. S. CADELL.

### "Precision Photographic Timer"

WE have studied with interest the circuit described by J. G. Thomason in the February issue as we have ourselves used the Miller integrator for timing precisely intervals of the order of 15 minutes. The use of a Miller integrator in this way, in conjunction with a gas-filled triode, is covered by British Patent 613,565.

In practice, it is difficult to realize any advantage from the use of a Miller integrator. Valve ageing and supply voltage variations produce changes in the internal gain and hence in the effective CR product. The most consistent results are obtained when the charging voltage ( $e_{in}-e_n$ ), is high and reckoned in tens, or preferably hundreds, of volts. Mr. Thomason has shown that, in order to obtain a useful amplification of CR, it is, in practice, necessary to reduce  $e_{in}$  to a few volts. In consequence small variations in  $e_n$  (due to changes in contact potential between grid and cathode) have a significant effect on the time interval.

For these reasons we prefer to use a cold-cathode trigger tube in the type of circuit shown on page 177 of the April, 1955 issue of *Wireless World*. The economy of this simple circuit more than offsets the higher cost of the relatively large timing capacitor required. Using a 12- $\mu$ F capacitor, long exposure times may be obtained with comparatively low (and hence stable) timing resistors by using a 2.2-megohm variable resistor in series with a number of 2.2-megohm fixed resistors. As each fixed resistor is brought into circuit by a step switch, the exposure time is increased by 15 seconds. This arrangement has the advantage of allowing exposure adjustments by increments smaller than the  $\sqrt{2}$  steps suggested by Mr. Thomason.

We also have used a non-linear resistor such as "Atmite" for exposure compensation, though in a different circuit arrangement. Our experience has been

that its value for this type of work is limited by its high temperature coefficient.

The single-valve circuit referred to above appears preferable on grounds of simplicity, economy, stability, elimination of warming-up period and the wide range of supply voltages over which accurate compensation is provided. This circuit is protected by British Patents 656,275 and 667,296.

Ilford, Limited,  
Watford, Herts.

R. J. HERCOCK.  
D. M. NEALE.

J. G. THOMASON states (your February issue) that the anode should not be started at the full H.T. voltage, or initially there would be no voltage drop across the anode load resistor, no anode current, and therefore no gain. Actually there is no need for an "anode load" at all. If the anode load is disconnected, the capacitor will still commence discharging through the valve as soon as the relay contact A1 is opened, and the rate of discharge will be almost independent of any change in the H.T. voltage during the timing interval. The effective time constant will be:—

$$C(r_n + R[1 + \mu]).$$

Satisfactory operation will depend on whether the amplification factor of an EF37 is sufficient when the anode current is reduced to 1 $\mu$ A. This will have to be determined by experiment unless constant-current curves are available.

Twickenham, Middx.

G. A. ASKEW.

### Future of European Broadcasting

I WAS most interested to read G. H. Russell's article in the January issue on the replanning of the long and medium wavebands.

While his proposals—if they could be put into effect—would undoubtedly improve matters a great deal, I believe that they are open to two serious criticisms:

(1) One of his factors controlling allocations is "population"; surely this ought to be "number of receivers in use."

(2) I do not consider that international reception will be satisfactory, by modern standards, so long as the present 9-kc/s separation is retained. The shifting of local services to v.h.f. should eventually make it possible to use a separation of, say, 15 kc/s, for at least part of the medium wavebands, to be used by one station in each country, transmitting an "international" programme.

Handhead, Surrey.

G. H. STURGE.

### Non-linearity

IN the January issue of *Wireless Engineer* the Editor refutes statements he has seen to the effect that distortion due to non-linearity cannot be eliminated by opposite non-linearity. I have an uncomfortable feeling that this dunce's cap fits me, for having said (on p. 317 of your July, 1955 issue), "Unlike frequency distortion, the results of non-linearity in one unit of the audio chain cannot be compensated by opposite non-linearity in another." However, it is pretty clear from the *Wireless Engineer* Editorial that compensation of non-linearity is mainly if not entirely of academic interest and is unlikely to be of practical value even within a single unit, such as an amplifier, let alone between one unit and another, such as amplifier and loudspeaker. I doubt whether the Editor could seriously disagree with my statement within the limits of its context. Nevertheless on a point of strict accuracy I readily plead guilty, with acknowledgments to *Wireless Engineer*, and ask that the words "in normal practice" be understood after "cannot."

Bromley.

M. G. SCROGGIE.

**Burne-Jones "Super 90" Pickup Arm.** The price of this component is £11 11s plus £4 12s 5d tax and not £16 9s as stated on p. 119 of the March issue.



# More Lines for Colour?

By V. J. COOPER,\* B.Sc.(Eng.), A.C.G.I.,  
M.I.E.E., M.Brit.I.R.E.

AN OLD TELEVISION CONTROVERSY BROUGHT UP TO DATE

**T**HE glamour of more lines for our television pictures is once again being widely discussed and from some quarters comes the suggestion that we should adopt a 625-line system for colour television in Bands IV and V. Do we need more lines, and if we have them shall we get better pictures? These are the questions that the viewing public ask and usually expect an affirmative answer; for the number of lines in the picture structure is a property that all can appreciate, and, on first thoughts, the more the lines the better the picture. What is frequently overlooked, in a casual examination of the problem, is the fact that picture quality for a given fixed total information content in the picture is not just a matter of lines. During the past few months the technical press in U.S.A. has made several references to the better pictures we receive in our homes in Britain compared with those received in American homes: yet the Americans have 525 lines and we have only 405.

The difference could be due to a variety of causes, for example, camera control, amplitude linearity response, synchronizing stability, black level stability, apparent resolution, etc. One fact that may be contributory is that the possible horizontal resolution expressed as a fraction of the possible vertical resolution of the 405-line system, using 3 Mc/s bandwidth, is markedly superior to that for the 525-line system using 4 Mc/s bandwidth.

The superiority of the horizontal resolution in our system over that of U.S.A. standards, expressed in round figures on this basis, is about 45 per cent. It would appear that no one has so far published a subjectively derived figure for the optimum ratio of horizontal to vertical resolution, but on the evidence that exists it would seem that in this country we may be nearer the optimum than the Americans.

Let us for a moment consider one of the fundamental requirements in a television picture; the acknowledged requirement that the picture should be wider than it is high—why is this so?

Nature has given us eyes which are laterally spaced. This results in our having the property of vision perspective in the horizontal plane. We therefore appreciate more information that is presented horizontally. By and large, our world spreads around us laterally and the great majority of movement and interest is horizontal. Cinemascope, Vistavision and the other new forms of picture presentation underline this human tendency to enjoy more breadth of vision than height of vision.

It would seem fantastic if cinema screens were made high and narrow instead of wide and shallow. If further proof be needed, the simple experiment of breaking up a line of typescript characters by horizontal lines and a similar line of typescript by vertical lines so that individual letters are mutilated, will demonstrate that as long as horizontal continuity

is preserved the words are much more easily read than when horizontal continuity is destroyed.

The conclusion to be drawn so far, therefore, is that we must preserve horizontal continuity and extend the amount of information horizontally. Fink† suggests that we can usefully extend horizontal information by 50 per cent and this is confirmed in a *Wireless World* article.‡

How do these requirements fit into a television system? The basic factor of television transmission is that the maximum amount of information that can be sent is a function of the bandwidth of the system. In this country, for the 405-line system we use a picture bandwidth of 3 Mc/s; in the U.S.A., for 525 lines, about 4 Mc/s is used, and in Europe, for 625 lines, about 5 Mc/s.

## A Limited Commodity

Bandwidth of transmission is directly related to the number of stations that can be operated in a given band of assigned frequencies. Thus for 3-Mc/s vision band transmissions we can have more channels than the U.S.A. or Europe, or conversely for a given number of channels we need less bandwidth in the radio frequency spectrum.

This is a highly important consideration. R.F. bandwidth available in the foreseeable future is the one commodity in which we are definitely limited. It is, in fact, our capital asset in a bank which for the next 50 years at any rate will not be able to offer overdraft facilities. It is therefore foolish to dissipate this capital asset more rapidly than absolutely necessary. If to-day we use all the available bandwidth, the next generation will find expansion of radio services the more difficult. The conclusion to be drawn, surely, is that the best possible reasons should be forthcoming for any suggestion that bandwidth per channel should be increased. We should, on the other hand, be more concerned with reducing bandwidths used consistent with maintaining a reasonable service.

For a radio service providing entertainment, the use of 3 Mc/s for a vision channel is already outrageous—it occupies over 100 times the bandwidth of the accompanying high-quality sound channel and in terms of value for value the ratio is even greater. This statement is readily acceptable if one conducts the test of (a) looking at television with the sound off, (b) listening to the sound with no vision. The vision information on its own is far less valuable as entertainment than the sound by itself.

We are still a long way from achieving bandwidth reduction without sacrificing picture quality in

\* Marconi's Wireless Telegraph Company.

† "Principles of Television Engineering," Donald G. Fink, McGraw-Hill Book Company Inc. 1940.

‡ "Television Standards," *Wireless World*, Oct. 1948, p. 382, col. 1, line 20.

broadcast systems, although the present generation may, by the use of coding, achieve progress in this direction on closed-circuit systems. If we cannot reduce broadcast service bandwidths then at least we should conserve them, and this thought makes the possibility of using more lines far less attractive.

More lines means more bandwidth in transmitters, receivers and link systems and this inevitably means greater cost.

### Consequences of 625 Lines

To achieve a significant improvement in picture quality for, say, large-screen operation we should need to adopt, say, 625 lines, and to preserve the same ratio of horizontal to vertical resolution we should need a bandwidth of over 6 Mc/s. This is considerably beyond the basis of the European C.C.I.R. standards, which have a 5-Mc/s video band. Even 5 Mc/s instead of 3 Mc/s means a serious reduction of channels in a given allocated band of frequencies. In Bands I and III, for example, the U.K. system can use 13 channels while the European system, on 625 lines in the same range of frequencies, can use only 9 channels and each, of course, subject to this lack of horizontal information.

It is frequently argued that the 405-line standards are 20 years old and were the first in the world and are therefore somewhat out of date. Certainly other countries that have followed have progressively standardized on more and more lines.

However, this does not, *ipso facto*, mean that a 405-line system cannot produce all that is required for home entertainment. The quality of pictures we receive is not limited by the standards§ but by the price the public can afford or is prepared to pay.

At a price, it is very debatable whether 625-line C.C.I.R. European standards can give any better pictures than 405-line U.K. standards, despite the increased channel bandwidth and, even without price limitations, doubts still exist.

It is probable that reducing the lines from 625 to 525 within the same 5-Mc/s video bandwidth would improve rather than degrade the picture owing to the closer approach to reasonably balanced resolution, but even then the horizontal information factor would be less than we now have on 405 lines.

If we express the system goodness factors on a basis proposed by Hallows|| but related to actual observed resolution capability (i.e. vertical resolution is, say, 0.8 of number of lines¶) we get the following figures:

Europe 625 lines (5 Mc/s): goodness factor 0.8.

U.S.A. 525 lines (4 Mc/s): goodness factor 0.78.

U.K. 405 lines (3 Mc/s): goodness factor 1.14.

There are additional hazards due to multipath reception as the number of lines and bandwidth is increased, and these hazards will be more pronounced as we move into the u.h.f. bands.

For a bandwidth of 3 Mc/s the time of duration of one picture element is approximately 0.14  $\mu$ sec. The reception of signals by alternative paths of different lengths will cause an error in the time of arrival between the two signals. The speed of travel is about 186,000 miles per second, i.e. approximately 327 yards per  $\mu$ sec. Thus a secondary signal received

at high level by reflection from a local re-radiator giving a path difference of 46 yards will produce two received pictures displaced by 0.14  $\mu$ sec, i.e. halving the definition. As bandwidth is increased to permit more lines this effect is more pronounced; for example, for 5 Mc/s video signals the corresponding time for a picture element is 0.1  $\mu$ sec, which is the time delay of a second signal arriving with a path length difference of 33 yards. As the path length difference is reduced the strength of the secondary signal for a given re-radiator will increase and cause a corresponding increase in the visibility of the ghost image. Thus for the European standards there is more chance of ghost images of sufficient strength causing a loss of resolution than for U.K. standards.

The question of more lines would probably not be raised if we made the lines invisible by spot wobble or by shaping the focused spot. If we did this, and removed line visibility as a point of argument, the questions of resolution in vertical and horizontal directions and the optimum relation between these properties would form a more realistic basis for discussion.

When we come to colour television the same arguments apply, but there is a further factor which offsets any advantage that might be claimed for more lines. With shadow-mask colour c.r. tubes the line structure is, for all practical purposes, invisible and if colour television using these tubes sets the fashion for "no lines" television then, once again, arguments based purely on lines and line visibility will be pointless.

Economic factors must surely be predominant in deciding standards. In a classic paper on the British television service\*\* Sir Noel Ashbridge sums up the bandwidth and cost problem as follows.

"For all the main operations in television, from production in the studio right through to the receiver in the hands of the viewer, cost must constantly be kept in mind. The television standards adopted in the United Kingdom require only a 3-Mc/s signal bandwidth to produce a satisfactory picture. This restrained bandwidth keeps down technical complications and so reduces cost. It has enabled an economical signal transmission system to be developed and has made possible the design of high-power vision transmitters of relatively high efficiency. More important still, it has enabled the price of the simple domestic receiver to be kept down to a figure which permits wide sales. All parts of the transmission and reception chain would become more technically complex and more expensive with a higher-definition system. Any attempt to transmit a higher-definition signal over a system excessively restricted in bandwidth at any one link of the chain, whether such restriction is in the transmitter, the cable system, the receiver or elsewhere, can result in a received picture considerably inferior to that obtained from a 405-line signal handled throughout by properly designed 405-line equipment (Kirke 1948).

"It follows that a significant improvement in definition could be achieved only by incurring considerable increase in all-round costs. Thus the decision to maintain the 405-line system seems warranted by overall financial considerations as well as by the necessity for economizing in transmission channels."

\*\* "The British Television Service." Sir Noel Ashbridge. Proceedings of Joint Engineering Conference, 1951, Part II, page 491.

§ "Editorial Comment," *Wireless World*, Oct. 1948. "Choice of Television Standards," *Wireless World*, July 1950, page 249, second col. "Comparison of Standards."

|| "Television "Goodness Factor,"" R. W. Hallows, *Wireless World*, March 1949, page 87.

¶ "Principles of Television Engineering," Fink. Chapter II, Sec. 7, page 33, line 23.

# Components Exhibition

REVIEW OF TRENDS AT THIS YEAR'S R.E.C.M.F. SHOW

## RESISTORS

AN interesting development this year is a range of high-precision resistance elements for use in volume controls where reliability is essential and both resistance and linearity tolerances have to be held to closer limits than usual. These are made by Plessey and the resistance element is actually an integral part of the body of the control. This is a high grade phenolic moulding which is extremely hard and has a glass-smooth surface. The resistive part of this element is a carbon composition track and the "binder" consists of the same material as the main moulding. Resistive element and body are moulded in one operation, with contacts moulded in where required. A centre ring for the "take-off" of the wiper contact can be moulded in also. The actual resistance track is about 15 mils thick and almost any resistance grading can be provided. Elements of this kind were shown in single track, twin track, segmental and strip form. The extreme hardness of the element's surface ensures a very long life and exceptional stability.

A new development in the metallized glass resistors made by Painton is to deposit a microscopically thin film of precious metal on to a glass fibre little thicker than a hair and then wind this metallized fibre, like wire, on a ceramic former. Very high resistance values are obtained in a small volume. The resistance range



Section of Plessey high-precision resistive element showing track and moulded-in contacts.

(A) Painton "Metlohm" T-pad metallized-glass resistance network and (B) new metallized glass-fibre resistor.

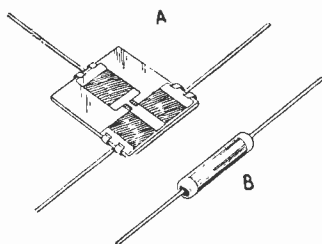

is comparable to that of high-stability carbon types, for example, but the permissible wattage is higher. A 1-watt glass-fibre resistor is about a quarter the size of an equivalent carbon type and about the same as that of a 1½-W wire-wound type. The resistor is protected by a coating of Araldite.

Shown also by Painton were some resistive T pads constructed on the "Metlohm" principle of a precious metal film on a glass plate zig-zag scribed to produce a long resistance track. By having the three elements on a single plate, and produced by the same operation, stability and temperature coefficient are the same for all three.

There were numerous minor improvements to the existing ranges of all makes of resistors, but these were mainly of a constructional kind to make the resistors more adaptable to printed circuit applications.

**Manufacturers:** A.B. Metal Products, British Electric Res., Colvern, Dubilier, Fgen, Electronic Comp., Electrothermal, Erg, Eric, Labgear, Morganite, N.S.F., Painton, Plessey, Salford, Walter Instruments, Welwyn, Zenith, W.B.

## CAPACITORS

A DEVELOPMENT of more than usual interest is the introduction by Eric of a capacitor having voltage-sensitive characteristics. It provides a controlled change in capacitance with applied d.c. voltages and would appear to have useful applications in f.m. receivers and a.f.c. circuits generally. The dielectric is a thin plate of piezo-electric material with metallized surfaces and while present models have capacitances of the order of

Dubilier new capacitors including "Terecap" (largest) and three miniature electrolytics.

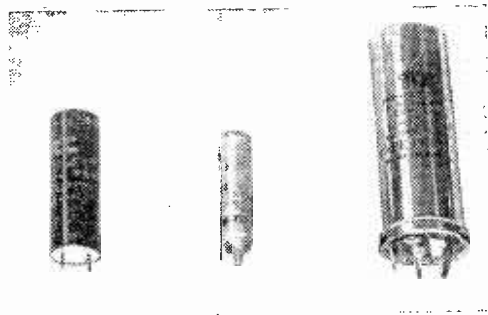

T.C.C. printed circuit capacitors, showing a 50- $\mu$ F Picapack, 32 + 32 + 16  $\mu$ F, 350V electrolytic and CPI9ON 0.27  $\mu$ F, 350V moulded-glass type.

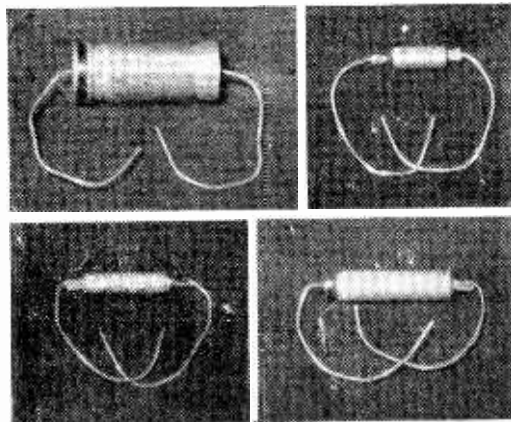

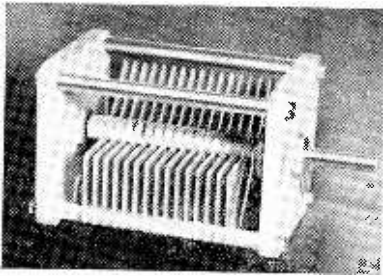

Eddystone Type 839 transmitting capacitor of 390 pF.



Right: Daly 32 + 16  $\mu$ F, 270 V with 25  $\mu$ F, 25 V electrolytic capacitors in a case only 1 in in diameter for printed circuits.

75 to 100 pF larger values should eventually be obtainable.

In general the changes in design of capacitors are of a superficial kind and concerned mainly with making existing types more adaptable for use in printed circuits. While many of the current ceramic and tubular types are small enough for this purpose their usefulness has been extended either by repositioning the connecting wires or by fitting wires more suitable for the dip-soldering technique of printed circuit assembly.

One example is the T.C.C. CPI90N, a 0.27- $\mu$ F 350-V tubular housed in a  $\frac{3}{8}$ -in diameter moulded plastic case  $1\frac{1}{2}$ -in long with both wires brought out through a hard resinous wax seal at one end. Hunt had some new ceramics in disc and tubular form with connections positioned to suit printed circuit assembly and, in addition, a low-leakage range of polystyrene film capacitors.

Dubilier showed a new range called "Terecaps" which employs a Terylene film dielectric. In size they fall midway between metallized paper and separate paper and foil types and their principal characteristic of interest is that they can be used without derating up to 125 deg C. They are fully tropicalized, being hermetically sealed in metal cases.

Electrolytic capacitors are in general somewhat smaller this year for a given capacitance and in order to cater for printed circuit requirements there is an increase in the number of multiple-capacitor types modified for this purpose. The principal modification is in the positioning and shape of the fixing lugs and contacts. All these are located at one end of the capacitor. Whilst it is customary to restrict the multiple types to either high- or low-voltage capacitors, Daly have a range of mixed voltage types, one, for example, being 32 + 16  $\mu$ F at 275 V working with 25  $\mu$ F at 25 V working; these are in cases only 1 in in diameter and  $2\frac{1}{2}$ -in high.

On all the new models of printed-circuit metal-cased electrolytic capacitors the fixing lugs and base connections have an agreed shape and spacing and this generally conforms to the American standard for this type of capacitor.

Variable capacitors have not undergone much change, but some new models were seen. One of these was an Eddystone (Stratton) transmitting type which is assembled on  $2\frac{1}{2}$ -in square ceramic end-plates with all the metal parts heavily silver plated. It has a maximum capacitance of 390 pF and one of its applications is in  $\pi$ -type networks for matching random-length aerials to the output valve.

**Manufacturers:** Cyldon, Daly, Dubilier, Erie, Hunt, J.B., L.E.M., Mullard, Plessey, Stability Radio, Static Cond., Stratton, Suffix, T.C.C., T.M.C., Wego, Wingrove and Rovers, W.B., Walter Instr.

## COILS AND TRANSFORMERS

AS one might expect, there were no major changes in iron-cored chokes and transformers, although a good deal of stress was laid upon the C-core types. There

was, too, perhaps more than ever before, great emphasis upon hermetic sealing and, for the smaller varieties, encapsulation.

As extremes in miniaturization, the Fortiphone transformers for transistor circuits are noteworthy, since the smallest types are only slightly larger than the average transistor.

For r.f. circuits, tuning coils and i.f. transformers were shown by many firms and have changed but little. Among new components a discriminator transformer for an f.m. ratio detector is interesting in being designed for 38 Mc/s. It was shown by Cyldon and can be used with either thermionic or crystal diodes. The bandwidth is 820 kc/s; it is intended for use in television receivers which provide Band II reception.

Mullard showed a range of wideband matching transformers wound on Ferroxcube E cores and also adjustable Ferroxcube pot cores, which can be supplied wound. These are for high-Q inductors and, as an example, Q values up to 350 can be obtained in the inductance range of 10-300 mH.

**Manufacturers:** Bulgin, Cyldon, Eddystone, English Electric, Ferranti, Fortiphone, Haddon, Lion, Mullard, Parmeko, Partridge, Plessey, Rola, Weymouth, Whiteley, Wireless Telephone, Woden.

## TELEVISION COMPONENTS

PARTS which are special to television comprise, in the main, scanning and focusing components, but it is also convenient to include tuners among them, although they are more in the nature of sub-assemblies than components.

The increasing use of 21-in tubes of 90° deflection angle has resulted in more deflector-coil assemblies for such tubes being produced. Some models were shown last year and the general form of the design on view this year was much the same, although detail differences exist. The castellated iron circuit, so common in assemblies for 70° tubes, is not used in the 90° types. Instead, a plain ferrite ring is employed; this is wound with four coils for the frame deflection so that these coils are of the so-called toroidal type. The line coils, however, are of the bent-up end kind and the front ends are flared to fit around the conical part of the c.r. tube. With the increasing scan power, insulation is becoming much more important and, in the Plessey assembly, it is provided by a polyethylene moulding; it is claimed that ionization does not start below 4.5 kV and, as the normal peak voltage is around 3.5 kV, there is a reasonable factor of safety.

A tendency to fit small permanent magnets to deflector-coil assemblies was noticed. They are in the form of rods, mounted vertically, one on each side of an assembly and on the outside. Their purpose is to correct for pincushion distortion of the raster.

Line-scan transformers are becoming almost conventional in their general form although detail changes are constantly being made. The core is invariably ferrite, or some material with similar electrical properties, with one window, the winding usually being on one limb only. Resistance wire is commonly used for the e.h.t. overwind to reduce ringing effects and supplies of 16 kV, and even 18 kV, are obtainable.

Focus components and ion traps remain substantially unchanged in form. The favourite arrangement is a pair of cross-magnetized rings acting in opposition and with adjustable spacing as a focus control. James Neill, however, retain the form which they introduced two years ago of three equi-spaced radial bar magnets within a pressed steel case. The case is in two parts movable with respect to each other, to give a variable air gap as a control of the focus field.

Turning now to tuners, there is little or no change in circuitry and the cascode r.f. stage with a triode-pentode frequency changer is normal. The turret tuner is common but the incremental-inductance type with switch selection is also widely used. The changes are in

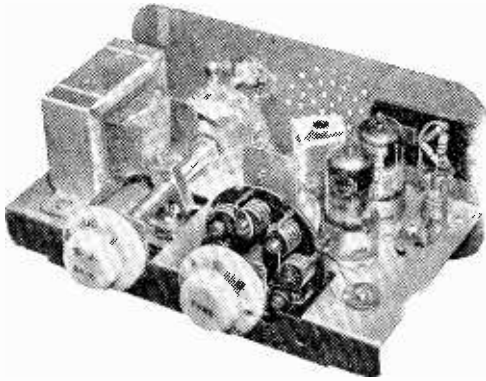

Wolsey Band III convertor with turret coil selector.

details. Improvements in the layout of components have produced small increases of gain and a lower noise level and, perhaps more important, better uniformity between different samples. Oscillator frequency stability is improving, too.

The Band III convertor is even less of a component than the tuner and very few were shown at the exhibition. Wolsey had one, however, in the form of a self-contained unit with a well-finished case, which is unusual in having a Band III turret for the oscillator coils. One switch gives a changeover between bands and the turret provides selection among the Band III channels.

**Manufacturers\*:** Aerialite (C); Cyldon (T); Long & Hambly (M); James Neill (F); N.S.F. (T); Plessey (D, F, T, Tr.); Thermo-Plastics (M); Whiteley (D, Tr.); Wolsey (C).

**\*Abbreviations:** C, convertors; D, deflector coils; F, focus units and ion trap magnets; M, masks; T, tuners; Tr, transformers.

## SUB-ASSEMBLIES

A VERY simple and flexible system for the construction and manufacture of sub-assemblies was demonstrated this year by Erie. Standard resistors and capacitors are selected and laid out on a tagboard, then wired into the required circuit and immersed in a sealing compound, leaving projecting pins for the connections. Anything between 2 and about 100 components can be assembled in this way, according to the customer's specification, and because there is no tooling involved it is quite easy to make changes to the circuits in the middle of a production run. The design is said to be suitable for automatic assembly methods in the manufacture of electronic equipment.

The general technique of "potting" sub-assemblies in blocks of resin was represented by many examples on the stand of Lion Electronic Developments. A particular unit of some topical interest constructed in this way was a voltage multiplier for supplying a 5-kV polarizing voltage for an electrostatic loudspeaker. Designed by Westinghouse, it contains 5 miniature tubular rectifiers and 6 small ceramic capacitors, and is intended to work from the 700-V a.c. provided by the 350V-0-350V winding of a mains transformer.

Sub-assemblies are very widely used in electronic computers, especially those designed on the "packaging" principle, and at the show this application was represented by a new kind of plug-in unit made by McMurdo. The valve and associated components are built into an inverted-U length of rod which forms both the main support and the handle for plugging in the unit.

A great many sub-assemblies are nowadays mounted on printed circuits, and a representative selection of such circuit plates was to be seen on the T.C.C. stand. This firm was also showing special printed circuits having the conductors flush with the surface of the base material; printed circuits on flexible bases (treated papers, resins,

polythene, etc.), and examples with conductors brought out to one edge for insertion into multi-way sockets or connectors.

There were, of course, quite a number of coil packs and filter units to be seen. Of particular interest on the Dubilier stand was a u.h.f. suppression filter, covering 200-1300 Mc/s, for insertion in the power supply leads of transmitting equipment. It is a double-T network, using two disc capacitors and a straight-through inductor wire with a ferrite sleeve, and is built into a small cylinder sealed with resin. The attenuation of the unit is in the region of 60db at 1300 Mc/s.

**Manufacturers\*:** Aerialite (IS); Antiference (IS); Bakelite (PC); Belling and Lee (F, IS); B.I.C. (DN); Bulgin (IS); Cyldon (TD); Dubilier (DN, F); Ediswan (TD); Electro Methods (PC); Erie (IS, CA, PC); Ferranti (DN, F); Hunt (IS, PC); Labgear (BE, F, IS); Lion (DN, CA, F); McMurdo (CA); Morganite (IS); Mullard (F, TD); N.S.F. (TD); Plessey (F, IS, PC, TD); Static Condenser (IS); S.T.C. (BE, IS); Stratton (TD); T.C.C. (DN, IS, PC); Thermo Plastics (F); T.M.C. (IS); Walter (PC); Wego (DN); Westinghouse (RA); Weymouth (DN, F, TD); Wingrove and Rogers (TD).

**\*Abbreviations:** BE, battery eliminators; CA, component assemblies; DN, delay networks; F, filters; IS, interference suppressors; PC, printed circuits; RA, rectifier assemblies; TD, tuning devices.

## AERIALS

THE television aerials made by J-Beam have always been a little unorthodox in design; for example, the end-connected feeder to the Band I dipole adopted a few years ago; the skeleton-slot beams of last year and now the "Hornbeams" shown this year. The "Hornbeam" is a combined Band I/Band III aerial and, as the illustration shows, consists of a square combined

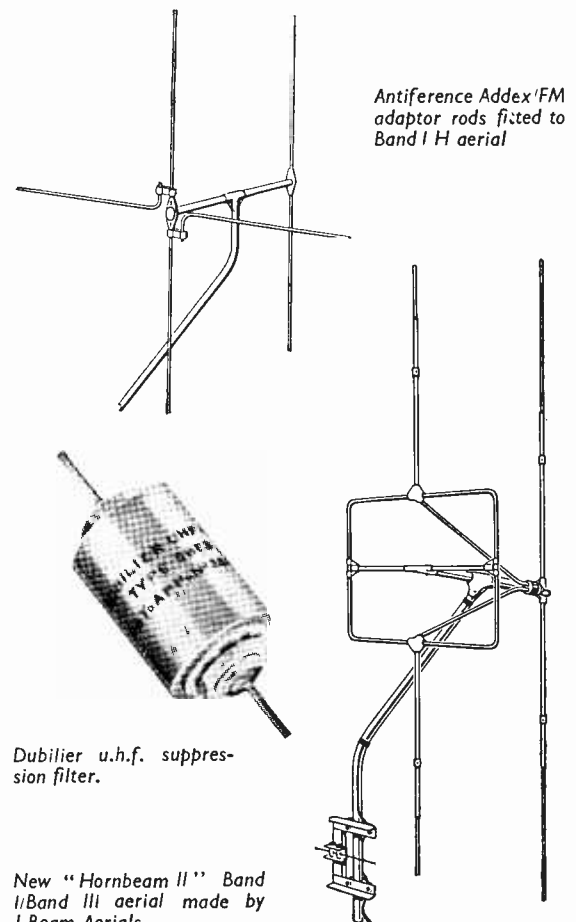

with a "V" with two vertical rods joined to the top and bottom sides of the square. Apart from these two rods the sides of the square and the arms of the "V" are all approximately a half-wavelength long at Band III frequencies.

The skeleton square plus "V" section form the Band III system, and this is said to exhibit the unusually broad bandwidth of 170 to 230 Mc/s without the voltage standing-wave ratio exceeding about 1.5 to 1. The Band I section, consisting of the vertical rods and the two vertical sides of the square in parallel, is less broad so the vertical rods are adjustable for tuning to the required Band I channel. A 75-ohm coaxial cable is connected to the apex of the "V" and no cross-over network is required. It can be used either vertically, as shown, or horizontally.

Apart from this novel aerial the main changes appear to be towards consolidating the various designs introduced last year. Ranges have been extended and mechanical features improved where necessary. As an example the add-on elements made by Antiference have now been extended to include an Addex/FM set for use on vertical television aeriels and where the receiver has provision for f.m. reception.

More attention has been given to indoor Band III aeriels, as it appears that within 5 to 10 miles of an I.T.A. station this kind of aerial can quite often be used successfully. Wolsey have a small square aerial for standing on top of the receiver which they call the "HI-Q"; it consists of a full-wave dipole bent into a square with a small loading coil in the top side. Provision is made to plug in the feeder from a Band I aerial, and there is a cross-over network in the base.

A folded dipole bent in the shape of a "V" and mounted on a base, also with a cross-over network incorporated for a Band I aerial connection, was shown by Aerialite. It is known as the "Viking." Aerialite had also a new "Multiway" indoor aerial, mainly, but

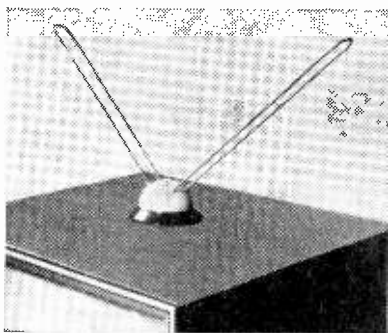

Aerialite "Viking" Band III indoor folded dipole.

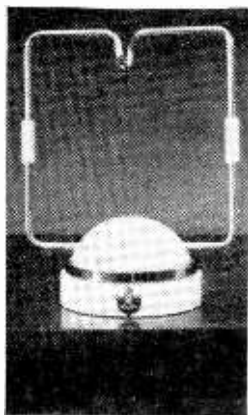

Left: Wolsey "HI-Q" Band III indoor aerial.

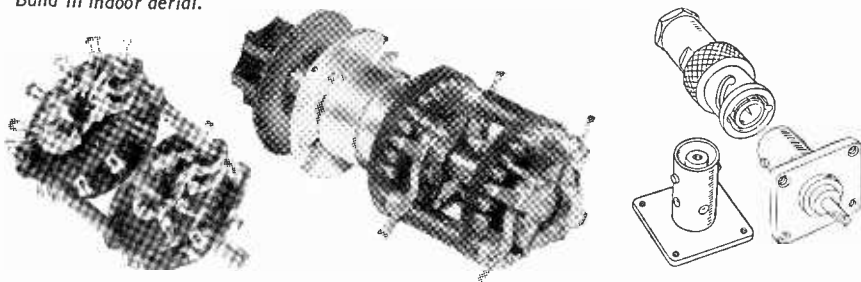

Above: Plessey rotary switch of improved construction. Centre: Electronic Components 4-pole 10-way instrument stud switch. Right: Besson and Robinson coaxial connectors with bayonet locking.

not exclusively, for loft mounting, which provides 18 different combinations of Band I, Band III or Band I/Band III aeriels according to the way the rods are inserted in the universal-type centre insulator. Another indoor aerial giving choice of several types, such as Vs, Ts, Ls, etc., was shown by Antiference. This firm has introduced also a simple coaxial cable plug in which the cable is fixed by crimping the sleeve of the plug on to the bared copper braid of the cable. The centre conductor has to be soldered in.

**Manufacturers:** Aerialite, Antiference, Belling-Lee, B.I. Callender's, Henleys, J-Beam, Labgear, Permanoid, Telcon, Telerection, Wolsey.

## SWITCHES

THERE were no really outstanding developments in the design of switches to be seen this year, but just a series of small improvements. In rotary switches some attention is being given to the better fixing of the stator contacts, which often become loose with continued operation. Walter Instruments, for example, were showing a switch in which the fixed contacts were locked in position by a staple clip. This gives improved security in operation and also prevents the contacts from being loosened by overheating during soldering. A similar improvement was to be seen in a new Plessey rotary switch. Here the contacts are held by a flat wedge type of rivet which not only gives better lateral support but enables them to be mounted on the surface of the wafer instead of in cut-away sections. This makes for a stronger wafer and incidentally allows the conventional rotor to be replaced by a more rigid assembly.

Two other new rotary switches were shown by A.B. Metal Products. The first was a new size, half-way between the ordinary "OAK" type and the miniature "OAK," and was notable for a simpler and cheaper index spring mechanism. The second was intended for switching very small currents in electronic instruments and was equipped with PTFE wafers having an insulation resistance of not less than  $10^{16}$  ohms. This firm also had a wide range of piano-action switches including several miniature types.

Micro-switches with a great variety of actuating mechanisms—plungers, levers, rollers, leaf springs—and actuating pressures were to be seen on both the Pye and Bulgin stands. Normally these switches do not lock into the closed state but Bulgin now have a number of models which do. This firm has also devised a system for ganging micro-switches.

**Manufacturers:**\* A.B. Metal Products (L, P, PA, R, S); B.E.R.C.O. (R); Bulgin (L, M, P, R); Diamond H (L, R); Electronic Components (P, R); N.S.F. (L, P, R, S); Painton (L, P, R); Plessey (L, P, PA, R, S); Pullin (R); Pye (M); T.M.C. (L, P); Walter (L, P, R, S); Whiteley (P, R, S); Wright and Weaire (R).

\*Abbreviations: L, lever or toggle; M, micro-switch; P, push-button; PA, piano action; R, rotary; S, slide.

## CHASSIS FITTINGS

IN this section probably the most topical trend in design was special fittings for printed circuits. Valveholders

(Continued on page 179)

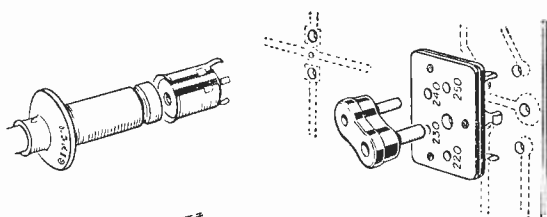

Above: Carr Fastener coaxial socket and mains-voltage selector for printed circuits.

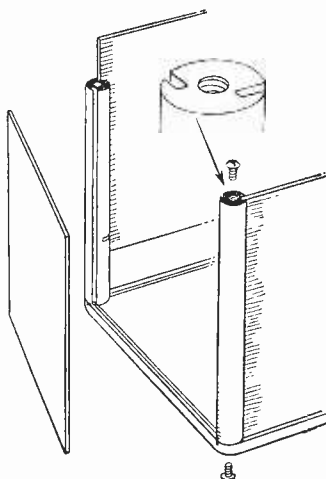

Above: Widney-Dorlec miniature cabinet system. Right: Electro Methods strip connector for printed circuits.

Right: Unusual Ediswan Clix holder for alphabetical indicator tube (16 contacts).

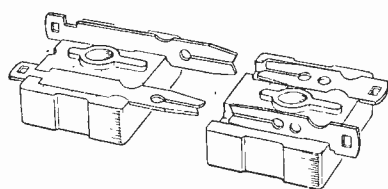
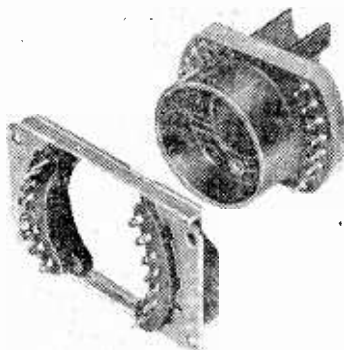
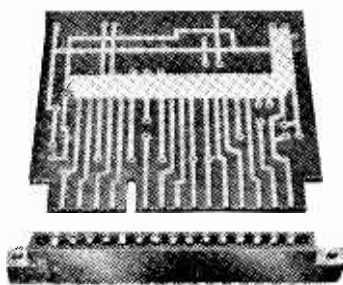

Basic units of the N.S.F. "Varicon" unitized connector system. These can be stacked as required and secured by a central fixing screw through the holes.

for this application are quite common now and also strip connectors for linking the circuits with conventional wiring; usually one side of the connector forms a long socket into which an edge of the printed-circuit plate is pushed. Two of the latest fittings in the printed-circuit category, shown by Carr Fastener, were a coaxial socket and a mains-voltage selector (see sketch at top of page).

Amongst the more conventional fittings, multi-way connectors of miniature construction were shown by several firms, while McMurdo had plugs and sockets moulded in nylon which were notable for their very low insertion force.

A particularly interesting form of construction for connectors could be seen on the N.S.F. stand. It is used in a "unitized" system in which plugs and sockets of any size can be built up from four basic parts, two contacts and two mouldings, and is best explained by the sketch. The contacts are unusual in that they fit into each other with their planes at right angles. The arrangement gives a very effective union between the surfaces and also prevents the plugs from being inserted the wrong way round.

Belling and Lee "Unitors" now have a modified socket giving reduced contact resistance and lower insertion force, and a lever-actuated extractor is a feature of the new design of retainer. This firm was also showing single nylon-insulated square-faced sockets in various colours. Amongst coaxial connectors, Besson and Robinson had some new miniature types in which the two halves are held together by a bayonet locking arrangement (see sketch on page 178).

Valve-circuit supports or turret assemblies (for mounting a valve and a small group of components) were shown in various forms by several firms this year, one using ceramic insulation. Usually they are cylindrical in construction, but Carr Fastener had a new type using straight tagstrips across the central support. Another device built around a valvholder was a mains-voltage

selector (McMurdo). The valvholder formed a socket, while a plug sliding on a central spindle could be rotated and inserted at different angular positions for the different voltages.

Cabinets can hardly be described as chassis fittings, but we must find a corner to mention a new type of "prefabricated" cabinet construction brought out by Widney-Dorlec. As can be seen from the sketch, it consists of a top plate (not shown) and a bottom plate fixed together at the corners by four aluminium rods, into which slots are cut (and also into the plates) for locating the aluminium or steel side panels. The method is only suitable for making up small cabinets and is intended principally for housing miniaturized equipments.

**Manufacturers:** Aerialite, Antiference, Belling and Lee, Bulain, Carr Fastener, Colvern, Creators, Ediswan Clix, Egen, Electronic Components, Electrothermal, Hassett and Harper, Hellerman, Igranic, Imhof, Long and Hambly, McMurdo, Micanite, Painton, Plessey, Power Controls, Ross Courtney, Salter, Simmonds, Spear, Standard Insulator, Stocko, Stratton, Thermo Plastics, Tucker Eyelet, Whiteley, Widney-Dorlec, Wimbledon, Wingrove and Rogers, Wireless Telephone Company.

## MATERIALS

ALTHOUGH the field of electrical insulants is nowadays dominated by the synthetic plastics it is interesting to observe that mica—one of the oldest known insulants—still plays an important rôle. By itself it is widely used as a condenser dielectric and for electrode bridges in valve manufacture; in combination with bonding media it finds application in a variety of proprietary sheet, tube and rod materials. A new injection moulding material "Mycalon" has been introduced by Mycalex and T.I.M., Ltd., in which the bonding medium is glass. It has been evolved in conjunction with the Ministry of Supply to meet conditions of high humidity and its initial surface resistivity of  $10^{13}$  ohms per square is recovered within one and a half hours after six humidity

cycles. The power factor is 0.0011 and the permittivity 9.6 at 1 Mc/s.

Fibre glass is much to the fore these days as a reinforcing material for silicone elastomers and other plastics. A coil former was shown by Langley London in silicone-bonded glass fibre in which the thread for locating a spaced-turn single layer winding was formed in the moulding operation. A fabric woven from glass fibre and regularly interspersed with metallic threads forms the basis of a resin-bonded radar reflector which was shown by Thermo-Plastics, Ltd.

Nylon is now firmly established with other plastics used in the production of insulating sleeving and is sought after for any applications requiring enhanced abrasion resistance.

In addition to the thermo-setting adhesive insulating tapes with paper, acetate and glass fibre backing, the Minnesota Mining and Manufacturing Company were showing an extruded PTFE tape designed for bonding by heat.

The substitution of a chlorine atom in polytetrafluoroethylene (PTFE) produces polymonochlorotrifluoroethylene (PCTFE), which exhibits comparable electrical, thermal and mechanical properties and is easier to mould. The Edison Swan Electric Company showed a wide variety of applications for these materials in radio components and as coverings for rollers and the jaws of heat-sealing machines where freedom from sticking is a fundamental requirement.

Cellular polythene, which came to the fore in Band III television aerial cables, is now being applied by B.I.C.C. to a wider range of r.f. cables with improved performance. The use of "Irraydol"—a brand of irradiated polythene—is something of a novelty among the r.f. cables made by Wandleside Cable Works. Although the power factor is slightly lowered, the thermal stability is increased up to 200°C and there is greater resistance to attack by mineral oils.

Among new instrument wires a solder-coated wire for dip-soldered assemblies by Henley's, and a bunched textile-covered wire with self-fluxing enamelled strands by Fine Wires were noted.

Refinements in melting and heat treatment have resulted in magnetic materials (both soft and hard) with enhanced performance characteristics. The Telegraph Construction and Maintenance Company are now producing "Super Mumetal" with initial and maximum

permeabilities of 50,000 and 200,000 compared with 25,000 and 90,000 for the standard alloy. "Special Radiometal" is now available with initial and maximum permeabilities of 4,500 (2,000) and 45,000 (25,000). Another Telcon achievement is the production of Mumetal 0.0007-in foil in widths up to 6in for use in radar pulse transformers and other high-frequency applications.

In the permanent magnet industry a decision has been taken by member firms of the Permanent Magnet Association to proceed with the commercial production of "semi-columnar" magnets in a limited range of sizes and proportions. While not showing the spectacular performance of the experimental "Columax" these "S.C." alloys show a marked improvement over "Alcomax" at an economic price. Much ingenuity is evident in the design of composite magnets with a variety of methods of bonding the soft and hard components. James Neill showed the versatility of the resin-bonding technique and Swift Levick gave examples of a dowelled intercast method of producing composite sintered and cast iron/Alcomax instrument magnets.

**Manufacturers:**\* Aerialite (C, IS, W); Aero Research (IM); Anglo-American Vulcanised Fibre (CF, IM); Associated Technical Manufacturers (B, C, IM, IS, W); Bakelite (IM); Geo. Bray (CE); B.I. Callenders (C, CO, IS, S, W); British Moulded Plastics (IM); Bullers (CE); Clarke (CF, IM, IS); Connollys (C, IM, W); Cosmocord (CF); Creators (IS); Darwins (M); De La Rue (IM, IS); Duratube and Wire (B, C, CO, IS, W); English Electric (L); Enthoven (S); Fine Wires (W); Guest, Keen and Nettlefolds (B); Hellerman (IM, IS); Henley's (C, CO, IM, W); Insulating Components and Materials, Ltd. (IM); Langley London (IM); Linton and Hurst (L); Lion Electronic Developments (IM); London Electric Wire and Smitting (W); Long and Hambley (IM, IS, RP); Magnetic and Electrical Alloys (L, M); Marrison and Catherall (M, L); Mica and Micanite Supplies (IM); Micanite and Insulators (CF, IM, IS); Minnesota Mining (IM); Mullard (DC, M); Multicore (S); Murex (RM, M); Mycalex (IM); James Neill (M); Permaoid (C, IM, IS, W); Plessey (CE, DC, M); Reliance Wire (C, CO, IS, W); Salford (DC, M); Sankey (L); Geo. L. Scott (L); F. D. Sims (C, CO, W); Standard Insulator (RP); S.T.C. (M); Steatite (CE); Suffex (B, CO, IM, IS, W); Swift Levick (M); H. D. Symons (IM, IS); Technical Ceramics (PC); Telcon (C, DC, IM, L, M, RM, W); Telcon Magnetic (L); Telephone Manufacturing Co. (DC); Thermo Plastics (IM); Tufnol (IM); United Insulator (CF, CE, IM); Vactite Wire (RM, W); Wandleside Cable Works (C, CO, W); Whiteley Electrical (CF, M).

\*Abbreviations: B, braiding; BO, bolts; C, cables; CE, ceramics; CF, coil formers, bobbins; CO, cords; DC, dust cores, ferrites; IM, insulating materials; IS, insulating sleeving; L, core laminations and strip; M, magnets and magnetic alloys; PC, piezoelectric ceramics; RM, refractory metals; RP, rubber products; S, solder; W, bare or covered wires.



## WORKED ALL ZONES

C. G. ALLEN, who is the first British amateur (G8IG) to win an international award for having made two-way 'phone contact with amateurs in all the forty zones of the world. This award, which comes from the United States, has been won only once before—by an amateur in Kenya—since it was first introduced some twenty years ago. "Bert" Allen is a director and sales manager of McMichael Radio, Ltd., which he joined in 1923, having previously been a ship's operator.



# British Colour Television

## A GLANCE AT THE PRESENT SITUATION

**T**HIS month a glimpse of the present state of British colour television development was given, in the form of demonstrations, to a study group of the International Radio Consultative Committee on a visit to this country. If these demonstrations helped to clarify the international minds of the C.C.I.R. people, they did very little to sort out the domestic situation as we see it in Britain at the moment. One feels the need for a general stocktaking of the situation.

First of all, then, what of the C.C.I.R. demonstrations themselves? These were arranged by the Post Office and included visits to B.B.C. establishments, to the G.P.O. Research Station and to E.M.I. Research Laboratories. Only one event, however, was thrown open to the Press. This was a demonstration in London by B.R.E.M.A. of various experimental colour receivers built by their member firms and working on N.T.S.C.-type transmissions radiated by the B.B.C. from Alexandra Palace.

The transmitting equipment at Alexandra Palace has already been described in *Wireless World*\* and also the essentials of the N.T.S.C. type of system†. There were 14 experimental colour receivers in operation and seven ordinary monochrome sets for showing the effect of compatible transmissions on existing black-and-white receivers. One of the colour receivers, described elsewhere in this issue, appeared to be in a more advanced state of development than the other equipments but could not be considered as a prototype for mass-produced domestic sets. This and several other of the receivers were built around the 21-inch RCA shadow-mask tri-colour c.r. tube. There were also sets using the earlier 15-inch RCA colour tube and some equipments with rear projection display systems.

In the view of *Wireless World* the pictures on the 21-inch direct-viewing receivers were markedly superior to the others—particularly in colour rendering, brightness and definition. Indeed they were the best colour television pictures we have ever seen. That is not to say, however, that they were perfect. There was quite a wide divergence of colour rendering between different receivers, and in some cases the divergences appeared on the same set. On one screen, for example, the flesh colour of a performer's hands was completely different from that of his face, although neither could be said to be unnatural. On another set, the hue of an actress's lemon-yellow dress fluctuated from greenish-yellow to almost orange in a matter of a few seconds.

Some of the colour receivers were designed for operation on wide-band colour information and some for narrow-band colour information, but one could see no difference between the respective pictures, except occasionally in areas of very small colour detail.

The monochrome receivers, incidentally, gave a very good picture on the compatible colour transmissions and one had to examine the screens very closely in order to see the sub-carrier dot pattern. What was really remarkable, however, was the demonstration of "reverse compatibility"—that is, the colour receivers giving black-and-white pictures from ordinary monochrome transmissions (which the B.B.C. put out after the colour transmissions). It was difficult to believe that the black-and-white pictures were actually being produced by red, green and blue c.r.t. phosphors until one took a magnifying glass to the tube screens and saw the individual phosphor dots fluorescing in their respective colours.

This, then, was the British N.T.S.C. system—and one more experimental transmission to add to the many others that the B.B.C. have been doing in conjunction with B.R.E.M.A. over the past six months or so. But what of the other systems that are supposed to be under

consideration for a possible service in Britain? The three most important ones all work on the principle of transmitting the chrominance information on sub-carriers *outside* of the normal vision band (unlike the N.T.S.C. system). The first two of these three systems can be considered as being (perhaps) compatible with our present television service in Band I, because although the colour sub-carriers of the stations would overlap the vision bands of stations in adjacent channels, it is thought that the interference between them would not be too serious. (One of these "overlapping" systems uses two colour sub-carriers while the other has a single quadrature-modulated sub-carrier of the N.T.S.C. type.)

The third system under consideration is a wide-band one using two colour sub-carriers outside the normal vision band but *not* overlapping the adjacent channel. In other words, it requires a wider channel than is at present available in Band I and so would not be compatible with our existing service. It could, however, be used to provide a compatible service in Bands IV or V.

The fact remains, however, that none of these alternatives to the N.T.S.C. system has actually been investigated in a really practical way, and at the moment it seems they are only regarded as an insurance against the possible failure of the N.T.S.C. system. One very simple reason for this is, apparently, that the only suitable transmitting equipment available for tests is at present completely tied up with N.T.S.C.-type transmissions! Whether any such tests will be carried out eventually on the alternative systems remains to be seen, but at the moment, at any rate, the N.T.S.C. system appears to be the firm favourite.

### Cost of Receivers

The choice of a colour system is influenced partly by whether we need compatibility or not,‡ and this in turn depends on a variety of political, social and economic factors. The question of bandwidth and conservation of ether space come into it also, and now there is controversy in progress on the matter of standards—whether we should go to 625 lines for colour or stick to 405 (see page 173). Perhaps one of the most important considerations in the choice of a system, however, is whether it will allow receivers to be mass-produced for the domestic market at reasonable prices.

At least one firm in Britain has worked out in detail the cost of manufacturing receivers for operating on the N.T.S.C. system, and it seems that the price cannot be brought much below £300 for a set. This is much too high to make colour television a practical proposition. It should be said, however, that receivers for the alternative systems would probably cost almost as much, for in all of them a simultaneous colour display system has to be used, and this is what accounts for the biggest proportion of the total cost. Receiver circuitry with some of the alternative systems is likely to cost less than with the N.T.S.C. system because of the simpler demodulation of the chrominance signals, but it is still necessary to have extra equipment of some kind for colour, whatever the system. On this question of receiver cost, then, it seems there is not much to choose between the systems at present under consideration. What is needed is a completely new system which requires simple circuitry and an inexpensive colour display apparatus—something as simple and inexpensive as the old frame-sequential system—but that is unlikely to be found. It is more probable that we shall have to adopt one of the four systems already described and put our trust in future development to reduce the cost of the colour display apparatus and the complications of the circuitry.

\*"Colour Television Tests," *Wireless World*, December, 1955.

†"Transmitting Colour Information," *Wireless World*, August, 1955.

‡"Must We Have Compatibility?" *Wireless World*, December, 1954.

# MODIFICATIONS TO THE Sensitive Three-Valve T.R.F. Receiver

CIRCUIT CHANGES FOR OPTIMUM  
PERFORMANCE WITH 6F33 VALVE

By H. E. STYLES, B.Sc.

IN notes on the above receiver, published in the January (1956) issue of *Wireless World*, it was stated that a 6F33 might be employed as an alternative to an EF50 with a diode connected between suppressor and cathode. It may be desirable to point out that owing to differences between the operating characteristics of 6F33 and EF50 valves a direct substitution is not practicable and an appropriately modified circuit for the r.f. and detector stages is given here. Comparison with Fig. 5 on page 618 of the December, 1955, issue of *Wireless World* will show what modifications are required.

These changes ensure that the 6F33 operates with a cathode potential of about 100 V and a cathode current of about 5 mA. Maximum screen dissipation is thereby limited to 0.8 W specified by the valve maker.

It was found that owing to the somewhat lower gain obtainable from a 6F33, reaction becomes inadequate unless a 100 pF capacitor is shunted across the cathode resistor. Introduction of this capacitor reduces negative feed-back of r.f. potentials to the grid of the detector

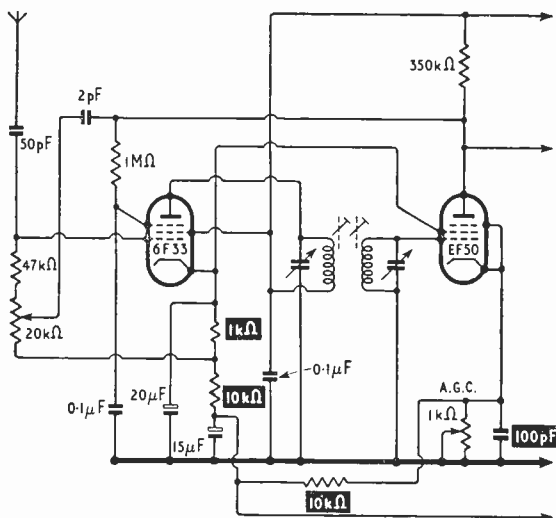

The modified circuit discussed in the text.

valve. As a consequence, the latter valve produces a greater amplitude of r.f. at its anode and reaction is thereby enhanced sufficiently to outweigh the reduced gain of the r.f. stage. It is probable also that detection efficiency may be improved by addition of this capacitor.

The 6F33, which can also be obtained under the designation CV239, possesses a much shorter suppressor grid base than the EF50. This is distinctly advantageous in that it enables adequate gain control to be obtained on a strong signal without depressing the anode potential of the detector valve to any marked extent. Detector overloading is thereby completely obviated and a longer aerial can be employed without risk of distortion on local stations.

## CLUB NEWS

**A.W.R.A.R.S.**—Membership of the recently formed Army Wireless Reserve Amateur Radio Society is open to any serving or past member of the Army Wireless Reserve Squadron or any other Royal Signals unit. Details of the Society's activities, which are stated to be entirely non-military, are obtainable from the chairman, A. D. Taylor (G8PG), 37 Pickerrill Road, Greasby, Wirral, Cheshire, or the secretary, J. A. Bladon (G3FDU), "Madresfield," Jack Lane, Davenham, Northwich, Cheshire.

**Barnsley.**—At the May 11th meeting of the Barnsley and District Amateur Radio Club, J. Ward (G4JJ), chairman of the club, will speak on transistor developments. Meetings are held on alternate Fridays at 7.0 at the King George Hotel, Peel Street, Barnsley. Sec.: P. Carbutt (G2AFV), 33 Woodstock Road, Barnsley.

**Birmingham.**—C. H. Banks, of C.J.R. Electrical and Electronic Development Limited, will speak on "Industrial Control" at the May 11th meeting of the Slade Radio Society. A fortnight later N. B. Simmonds will deal with rectifier circuits. Meetings are held at 7.45 at the Church House, High Street, Erdington. Sec.: C. N. Smart, 110 Woolmore Road, Erdington, Birmingham 23.

**Bromley.**—At the monthly meeting of the Bromley Radio Club (North West Kent Amateur Radio Society) on May 4th, there will be a discussion on the National Field-Day. Meetings are held at 8.0 at Shortlands Hotel, Station Road, Shortlands, Kent.

**Bury.**—The Bury Radio Society has recently been re-organized and meetings are now being held on the second Tuesday of each month at 8.0 at the George Hotel, Kay Gardens. Information on the club activities is obtainable from John E. Hodgkins (G3EJF), 24 Beryl Avenue, Tottington, near Bury, Lancs.

**Chelmsford.**—The next meeting of the Chelmsford group of the British Amateur Television Club will be held at 7.30 on May 10th in Marconi College, Arbour Lane, Chelmsford. F. H. Townsend, vice president of the club, will speak on "Recent developments in camera tubes." Sec.: D. W. Wheele (G3AKJ), 56 Burlington Gardens, Chadwell Heath, Essex.

**Checkheaton.**—"Multi-channel telephony" is the title of the talk to be given by E. G. Smith (G.P.O.) on May 2nd to members of the Spen Valley and District Radio and Television Society. On the 16th G. F. Craven will deal with the interpretation of valve characteristics. A joint meeting of the Spen Valley, Leeds and Bradford societies will be held on May 30th at the Leeds G.P.O.; subject, "Transatlantic Cable". Sec.: N. Pride, 100 Raikes Lane, Birstall, near Leeds.

**Crystal Palace.**—The Crystal Palace and District Radio Club has been formed to widen the scope of the activities of the Norwood and District R.S.G.B. Group. Meetings are held on the third Saturday of each month at 8 in Windermere House, Westow Street, Crystal Palace. Sec.: G. M. C. Stone (G3FZL), 10 Liphook Crescent, Forest Hill, London, S.E.23.

**Edgware.**—The headquarters of the Edgware and District Radio Society (G3ASR) are now at Canons Park Community Centre, Merrion Avenue, Stanmore, where meetings are held each Wednesday at 8. Sec.: E. W. Taylor (G3GRT), 99 Portland Crescent, Stanmore, Middx.

**Portsmouth.**—Meetings of the Portsmouth and District Radio Society, which is affiliated to the Royal Marine Signal Club, are held each Tuesday evening at the British Legion Club, Queens Crescent, Southsea. Sec.: L. B. Rooms (G8BU), 51 Locksway Road, Milton, Portsmouth.

# Experimental Colour Receiver

THE COLOUR KILLER AND THE TRI-COLOUR C.R.T. CIRCUITS

BY H. A. FAIRHURST\*

(Continued from page 118, March issue)

IN a colour receiver it is not essential, but very desirable, that the chrominance amplifier should have automatic gain control, for although the receiver is itself controlled, this can do nothing about selective fading which may alter the relative amplitudes of the video and colour information. Therefore some means of obtaining a suitable control voltage must be found.

The colour synchronizing burst immediately suggests itself as the source of such a voltage, for it consists of a fixed amplitude and duration of just the frequency round which the colour information is centred. Very conveniently, too, it has already been gated out of the signal and is ready for use. The colour burst is rectified by a diode in a conventional manner and the resulting negative voltage applied to the grid of the first chrominance amplifier (Fig. 7). A delay diode delays the application of this voltage by a small amount.

The colour killer must now be described (left-hand side of Fig. 7). This is not an essential part of a colour receiver but it is a desirable adjunct, for in its absence a monochrome picture received on the colour receiver could be crawling with the coloured noise called "parc." This effect is due to the inability of the colour demodulators to distinguish between chrominance sub-carrier plus sidebands and luminance information which contains similar frequencies. Such frequencies in the luminance band beat with the reference oscillator and produce coloured streaks of light, or, in the case of the higher frequency blocks of Test Card C, bright rainbow hued bands. The colour killer is therefore a circuit which "kills" the chrominance amplifier in the absence of a colour sub-carrier, i.e., on a monochrome picture, and as a colour sub-carrier is or can be arranged to be always accompanied by the colour burst, the killer can be made to depend on the presence or absence of the burst.

It would seem at first glance, therefore, that the colour killer must be possessed of magical properties, unless it is to consist of a separate amplifier chain and rectifier in parallel with the chrominance amplifier, provided solely to kill the chrominance amplifier in the absence of the burst. Otherwise the colour killer must be able to "know" when the burst is there, and this possibly when the amplifier is already cut off because a monochrome picture has been transmitted just previously. Fortunately circuits exist which perform this task and recourse to the expensive alternative is not necessary.

The colour killer circuit adopted in this receiver (Fig. 7) makes use of the fact that it is possible to observe whether the burst is present or not once a line, notwithstanding the fact that the chrominance

amplifier is cut off during the rest of the line period. A suitably timed positive-going pulse is applied to the grid of the a.g.c.-controlled and colour-killed chrominance amplifier which brings it into a state of conduction. If there is a burst present, this is amplified normally and is rectified to produce the a.g.c. voltage. As well as controlling the gain of the first chrominance valve, this negative voltage also controls the colour killer, which has positive-going gating pulses on its anode and negative-going pulses on its grid derived from the line timebase.

## Colour Saturation Control

In the presence of a burst, and hence the presence of the negative a.g.c. voltage, the colour killer is cut off and the negative-going pulses on its grid have no effect on the anode circuit. However, in the anode circuit are positive-going pulses whose amplitude is adjustable by the potentiometer, and these pulses drive the chrominance amplifier into grid current, thus providing a bias in addition to that of the a.g.c. voltage. As the amount of this additional bias is controllable by the potentiometer, this becomes a very convenient "saturation" control.

Taking the case where no burst is present, the a.g.c. voltage becomes zero, thereby causing the colour killer to conduct. The negative pulses on its grid now produce large positive pulses on the anode which in their turn cut off the first chrominance amplifier by virtue of the grid current that flows. It will be seen, however, that the chrominance amplifier is always switched on during the time interval when the burst occurs; therefore the killer circuit is always able to recognize whether the burst is there or not. A potentiometer allows the setting of the killer bias to the correct working point.

A thing worth noting with this arrangement of switching the amplifier to full gain during the burst

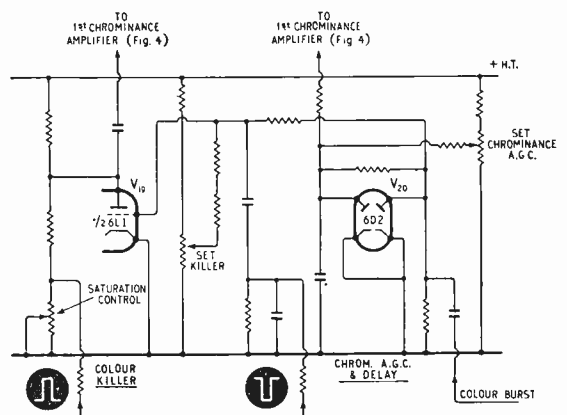
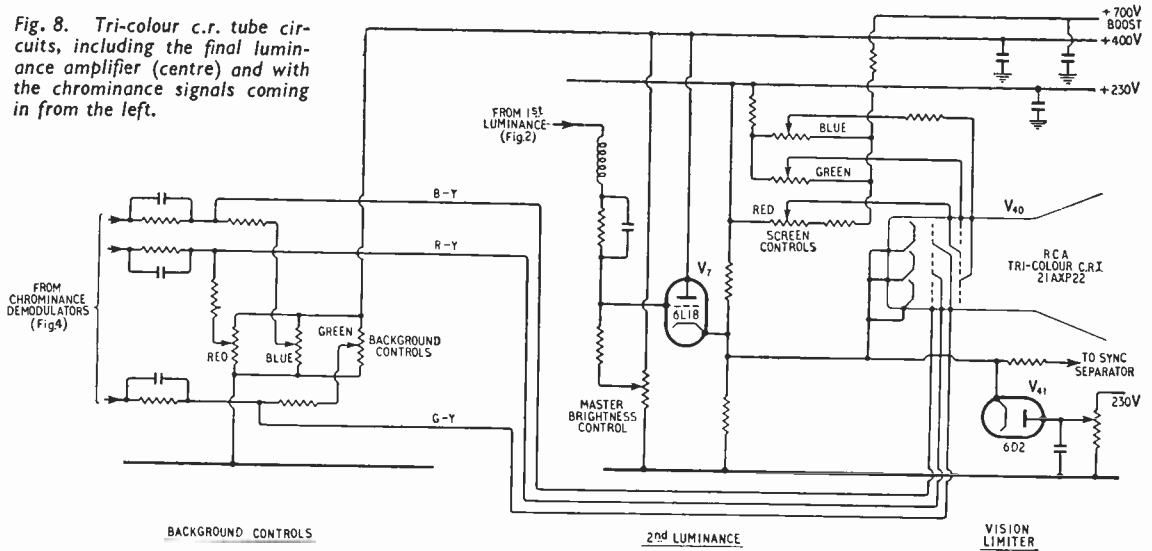

Fig. 7. The colour killer and chrominance a.g.c. stages.

\* Murphy Radio. This article is based on a lecture given by the author to the Television Society. The receiver, among others, was recently demonstrated operating from "live" B.B.C. test transmissions on the occasion of the visit of C.C.I.R. Study Group XI to Britain.

Fig. 8. Tri-colour c.r. tube circuits, including the final luminance amplifier (centre) and with the chrominance signals coming in from the left.



period is that perfect a.g.c. control can be achieved with only one controlled valve, an impossibility with normal circuits.

Before dealing with the timebases and ancillary equipment it will serve a useful purpose to enumerate the requirements of the three-gun shadow-mask c.r. tube. First and foremost there must be means for adjusting the individual electron guns so that their cut-off points fall at the right

voltage with, at the same time, the right length of grid base. Without this possibility the tube would give the correct colour rendering at one brightness only. Secondly, the three electron beams must be made to strike the shadow mask at substantially the same spot over the whole of the picture area. Thirdly, the scanning generators must be capable of delivering sufficient power to scan the tube—at the elevated e.h.t. which is required to give sufficient brightness and a good enough focus.

Right at the outset of the design, in order to save time, it was decided to use RCA components as far as possible in the scanning and e.h.t. circuits, but it was soon found that the line-scan transformer which was suitable for 525 lines was not equally suitable for the British 405 lines. The work on the display side therefore divided itself into two parts: the design of a line-scan circuit which would scan the tube and produce a stabilized 25-kV e.h.t. supply capable of delivering 1 mA, and the donkey work of adapting the American tube control circuits to suit the particular receiver.

Taking these last-mentioned circuits first and referring to the circuit diagram (Fig. 8) it will be seen that there are three "background" controls which enable the R, G and B guns to be set to the correct level of brightness. These are set in conjunction with the three screen controls which are in effect potentiometers between the boost line and + h.t. These latter provide an adjustment of the grid bases of the individual guns, the cathodes, grids and screens acting as triodes. Once these six controls are set, the picture brightness can be altered by the master brightness control, which is in the cathode-follower circuit.

Included in the circuits which had to be adapted to the present receiver are the vertical and horizontal shifts. If it is not obvious from the outset that a tube containing three separate electron guns requires something more than a shuffle plate if the registration is not to go amiss when shifting the picture, it very soon becomes self evident that such simple devices are of no use.

In fact, the method adopted is that of passing d.c.

(Continued on p. 185)

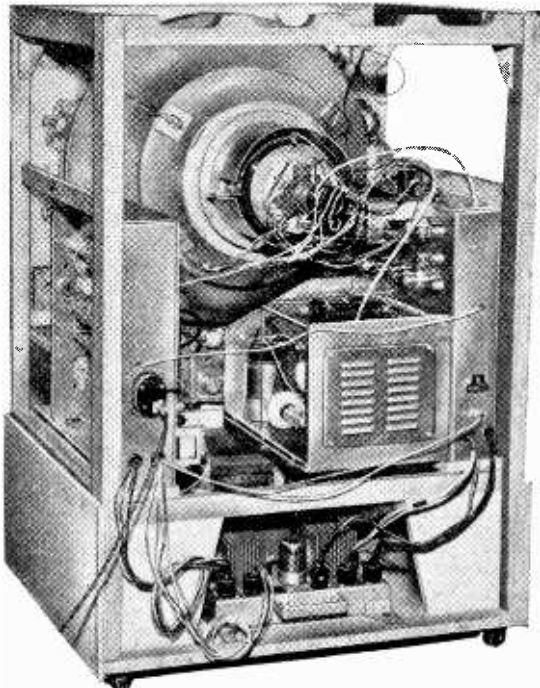

The accessibility obtained by making the sides of the cabinet detachable. The timebase and e.h.t. chassis on the right has its screen removed. The dynamic convergence yoke can be seen on the end of the tube.

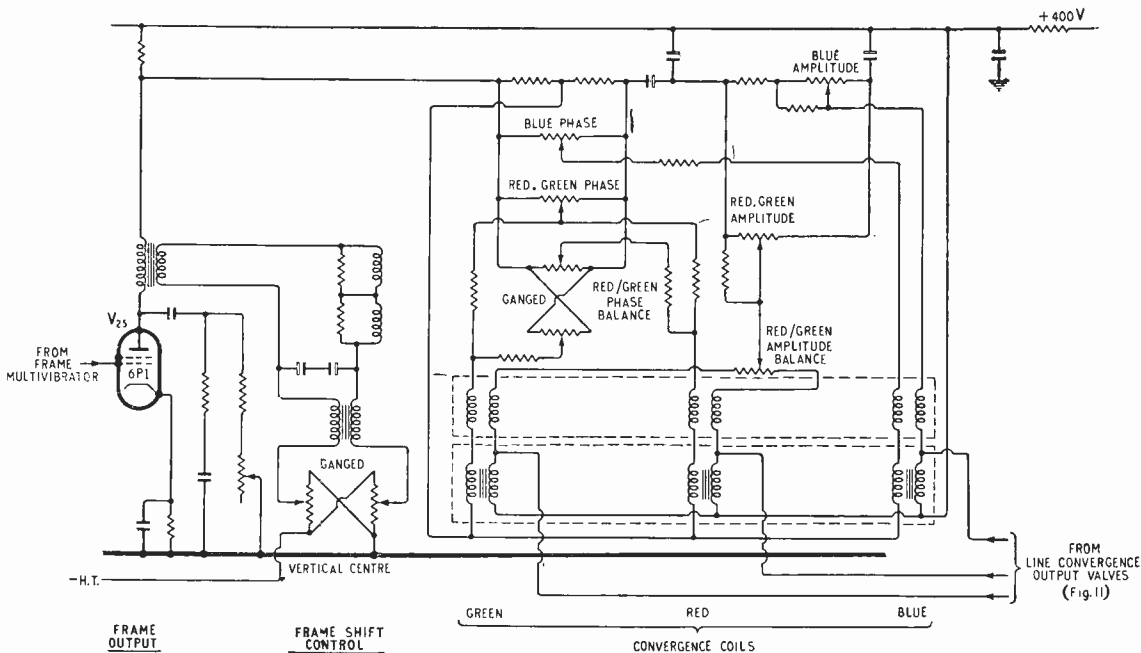

Fig. 9. Frame convergence circuits, including the frame timebase output valve (left) and the convergence coils.

through the scanning coils themselves, and as the scanning currents must not be short-circuited through the power supply, suitable decoupling chokes must be provided. As it is desirable to be able to shift the picture both ways, dual cross-connected potentiometers are provided. The frame shift control (Fig. 9) is isolated from the scanning circuit by a suitable transformer and high-value electrolytic capacitors while the line shift (Fig. 10) is isolated by chokes and the d.c. prevented from getting into the line transformer by isolating capacitors.

Before dealing with the timebases themselves, and taking the last of the display requirements peculiar to the shadow-mask tube, we come to the convergence circuits. These are circuits for energizing an additional scanning assembly known as the convergence yoke. Into this assembly are fed currents of suitable amplitude and phase for adjusting the beam position of all

three guns so that they coincide all over the face of the tube. The convergence yoke differs from the ordinary scanning coils in that it has three coil assemblies on it, each one of which has its greatest effect on one gun only. Into each individual coil assembly can be fed currents derived from the line and frame timebases.

The form of the currents required for convergence in a vertical direction is largely parabolic and can be

Fig. 10. Line timebase output, showing line shift control circuit and e.h.t. rectifiers.

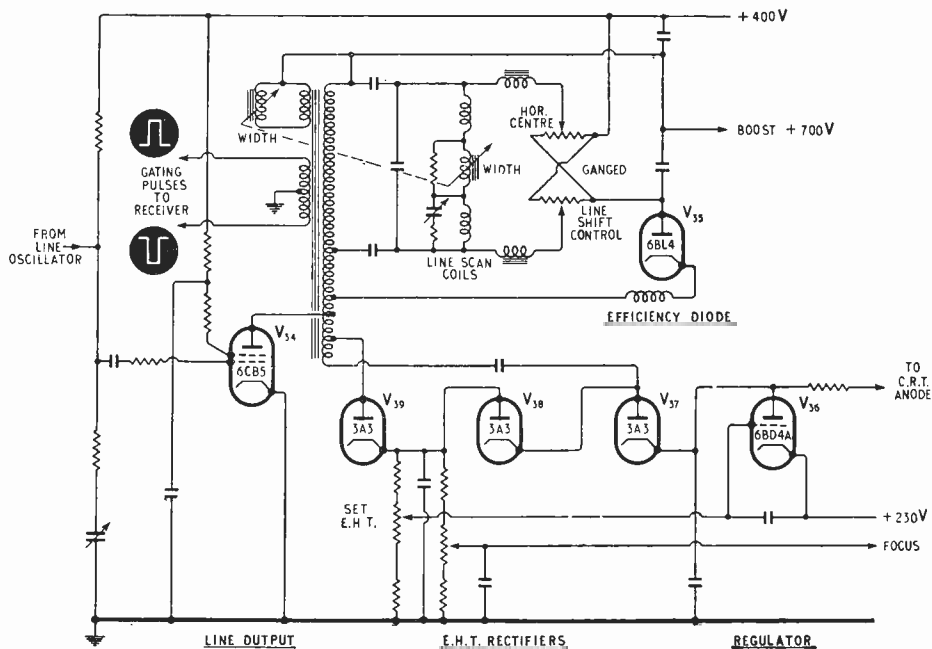

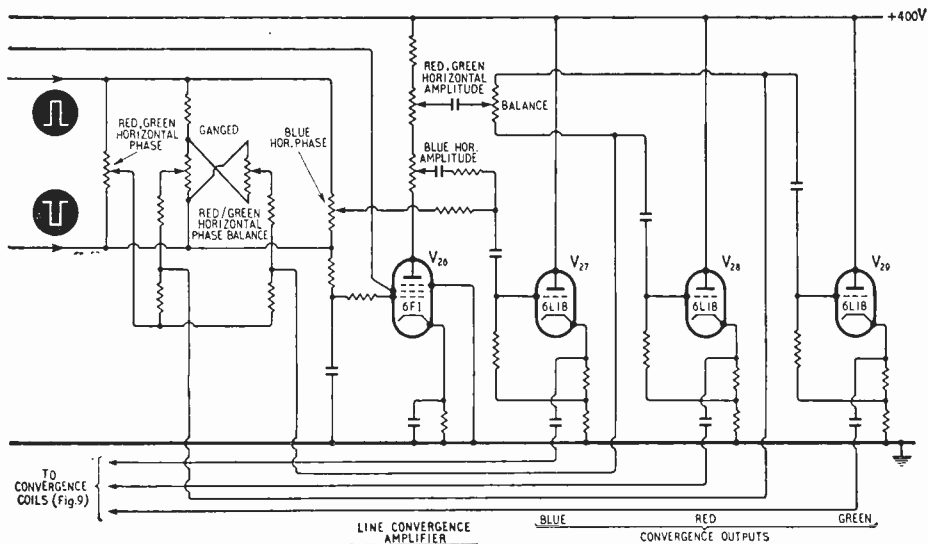

Fig. 11. Line convergence amplifier and output valves.

derived from the frame timebase by suitable R and C circuits (Fig. 9). There naturally have to be three outputs, each controllable both in amplitude and phase. In the case of the horizontal convergence, an attempt was made to carry out this operation with static circuits on the lines suggested in information supplied by RCA, but without a great deal of success. It may be that a reasonable compromise can be reached at 15 kc/s, whereas it cannot at 10 kc/s, or it may be that we had set our standards rather higher, but in the end it was decided to use valves for the job, and the circuit shown in Fig. 11 was the result.

In this circuit, integrated pulses from the line timebase fed on to the grid of the amplifier valve appear in amplified form on its anode. The correct proportions of this amplified sawtooth are fed on to the grids of the three convergence output valves in conjunction with a pulse from the line timebase in such a manner that the resulting waveform drives the correct current through the convergence coils. The output valves are merely cathode followers to obtain the low impedance source that is necessary.

Controls are provided to adjust both the amplitude and phase of the pulse and sawtooth, and in practice these are adjusted until the correct current waveform is produced. The correct current is of course that which gives the best convergence of the three beams over the whole screen, and as the line and frame convergence controls are by no means independent of each other, it will be appreciated that the correct setting-up of the convergence is no mean feat.

Turning now to the timebases themselves, the frame timebase (Fig. 9 shows the output valve) can be dismissed in very few words, its sole departure from normality being the amount of current required to scan the tube. As, however, the sensitivity of the frame coils is relatively high, a normal 5-watt output valve is quite suitable.

The line timebase, however, is some-

what specialized in that it has to provide an e.h.t. supply of 1 mA at 25 kV in addition to scanning the tube. The circuit of the timebase itself is conventional, but it uses an American type valve, a 6CB5, in the output stage (Fig. 10) as being the only one available at the inception of the design capable of doing the job. The economy diode is also an American type — a 6BL4. The line timebase has to supply the necessary gating pulses for the receiver and these are provided by a special winding.

The line timebase is frequency controlled by a conventional a.f.c. loop, and here of course there was a wide choice of circuits available, although somewhat naturally the one chosen was a circuit in common use in our laboratories. The discriminator diode in this circuit has to be fed with equal amounts of positive- and negative-going sync pulses, and these are provided by a phase splitter valve which is half a double triode. The sync separator itself is conventional and needs no further mention. The other half of the phase-splitter double triode is used to remove the line clutter from the differentiated frame sync pulses before passing them on to the frame timebase.

As has been stated, the e.h.t. requirements for the shadow-mask c.r. tube are 25 kV at 1 mA (most of which goes into the shadow-mask itself) and this must be stabilized to ensure good registration at all picture brightnesses. A voltage doubler circuit has been used with a third rectifier as a one-way device to prevent the pulse on the anode of V37 from

The timebase and e.h.t. chassis, showing the complete screening achieved.

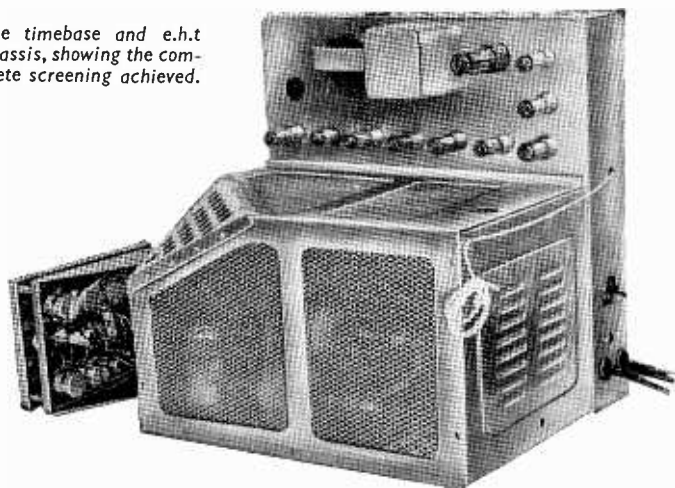

appearing on the cathode of V39. Shunted across the output of the supply is a stabilizing triode, a 6BD4A, which has been specially developed for the purpose. Its grid is connected to a tap low down on a potentiometer between the cathode of V39 and earth, and this tap can be varied to control the e.h.t. In action the total current drawn by the c.r. tube and the stabilizer valve is more or less constant, as any change in the loading of the c.r. tube alters the grid voltage of the stabilizer in such a sense that the change of current through it compensates almost exactly.

The shadow mask c.r. tube, being electrostatically focused, needs a source of focusing voltage, and this is provided by a shunt across the "undoubled" e.h.t. rail.

There remains only the h.t. power supply, whose only out-of-the-ordinary feature is the number of milliamps required. The actual equipment contains two large metal half-wave rectifiers in a doubling arrangement, providing a 230-V rail and a 400-V rail, with a total consumption of 600 milliamperes. The 400-V rail is used to feed the timebases, the luminance cathode follower and the chrominance demodulators, while the 230-V rail feeds the receiver section, the screen grid of the frame output valve, and the screen grid of the horizontal convergence amplifier. In series with the common h.t. return is a small resistance which provides a negative source of 10 volts for the frame shift.

A receiver using 40 valves and a 21-in cathode-ray tube is naturally no small object, and when it is considered that the RCA shadow-mask c.r. tube has a metal cone at a potential of 25 kV it will be realized that something special has to be done to ensure the safety of the personnel operating it.

In view, also, of the uses to which the receiver was to be put, it was thought advisable that it should go through an ordinary living-room door, so considerable effort was put into the mechanical design, much more than would be necessary for the normal laboratory experimental receiver. Accessibility, too, was considered most important, and all the setting-up controls have been brought out to the front. The sides of the cabinet are detachable, allowing free access to the undersides of the timebase and receiver chassis, which are mounted vertically on each side of the tube. The power supply chassis is out of the way on the base of the cabinet.

In operation with the cabinet open there are no

exposed live parts other than ordinary h.t. and boost rails, and the boost feeds only the c.r. tube screen controls. The timebase is completely screened and the metal cone of the tube is protected by a polythene shroud, so no particular precautions against shock need be taken other than those normally adopted by engineers in the laboratory. With the cabinet closed, of course, there are no live exposed parts whatsoever, the metal escutcheon round the protective glass being bonded to earth. The protective glass is  $\frac{3}{8}$ in thick and is in itself a sufficient protection against X-rays.

The setting-up and operation of the receiver is not a subject that can be dismissed in a few words, as there are not only the convergence, screen and background adjustments to be made, but also the colour purity to check to ensure that the red, green and blue guns hit centrally the red, green and blue phosphor dots respectively all over the screen. This colour purity is controlled by movable permanent magnets on the neck of the tube. On a yoke round the periphery of the face-plate are adjustable magnets to compensate for stray fields. When it is considered that all these adjustments are more or less inter-dependent, it will be realized that the setting-up of a shadow-mask c.r. tube is more a matter for practical experience rather than a wordy description of the process. The matter will be dismissed, therefore, with the assurance that although the process may take nearly all day the first time it is attempted, skill is rapidly attained until the whole sequence can be gone through in an hour or so. There is also the saving grace that once set the adjustments appear to stay put.

In conclusion the author would like to convey a few messages of thanks to various people. To begin with, and speaking for all television workers, we in Britain certainly owe a debt of gratitude to the members of the N.T.S.C. committee in America, first for developing their extremely elegant system of colour television and secondly for being so forthcoming in the publication of results. Next, thanks are due to RCA for their assistance in supplying information and parts, without which the receiver would have been much longer in the designing, and to the B.B.C. for their immense help at all stages. Last, but not least, a "thank you" to the group of engineers without whose intense efforts the receiver would not have seen the light of day nor this article have been written.

ONE of the laboratories in the post-graduate School of Electronics established by Automatic Telephone and Electric Company and its associates, which include B.I. Callenders and Hivac. The School, which recently held its first open day, is situated within the company's main works at Liverpool and has at present accommodation for 30 students. There are two types of course provided—one lasting 3 months and the other a year. Prospective students are, in the main, selected from the company's staff and are paid whilst studying.



# Distortion—Audible and Visible

Relationship between Amplitude/Frequency and Phase/Frequency Response

By "CATHODE RAY"

A LITTLE quiet entertainment has been afforded by perusal of successive issues of British Standards in which the approved names for various kinds of distortion are set forth. As the older *Wireless World* readers may remember (and the younger ones too, if they have read the volume I have been plugging with a shamelessness rivalling that of the B.B.C. in their interview programmes—"Second Thoughts on Radio Theory"), one of my hobbies is hurling bricks at the promoters of misleading or illogical technical terms. British Standard 204 of 1943 provided a particularly attractive group of targets. One of them was "non-linear distortion," for my rude remarks on which see p. 388 of the book just mentioned. The footnote on its next page records with satisfaction that in BS.2065 of 1954 "non-

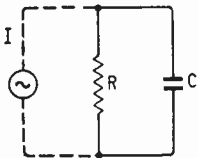

Fig. 1. The voltage set up across a resistance by a given signal current decreases with increasing frequency of current if there is a capacitance (intentional or otherwise) across it.

linearity distortion" was admitted as an alternative. Now, in BS.661 of 1955, "non-linearity distortion" has been promoted into first place and "non-linear distortion" banished altogether.

This little progression is satisfactory more as a sign that authorities may be open to reason than because of the objectionableness of the term in question, which is no worse than a little loose. A more outstanding target was "attenuation distortion," because it was not only not in general use but was no improvement on the term that was in general use—"frequency distortion," mentioned by BS.204 only to black-list it as "Deprecated." Now, although I myself have used "frequency distortion" I will readily admit that it is wrong. But at least it gives people a chance of guessing the correct meaning, whereas if "attenuation distortion" suggests any meaning at all it is unlikely to be the right one. Evidently the British Standards Institution began to think so too, for in BS.2065 they substituted the precise term "amplitude/frequency distortion," with "frequency distortion" as a permitted alternative. This was evidently too much for some of their advisors, for although in BS.661 "amplitude/frequency distortion" is retained as the recommended term we find "attenuation/frequency distortion" as an alternative and "frequency distortion" deprecated again. There is still some inconsistency, for whereas "phase distortion" is a permitted alternative for "phase, frequency distortion," "amplitude distortion" is a result of non-linearity and is not at all the same thing as "amplitude/frequency distortion." It will be interesting to see what the next edition of BS.204 says!

The reason for this preliminary argument about terms is that I find myself rather stuck by my own fussiness, for this month's subject is to be a comparison between what (to give them their precise names) I must call "amplitude/frequency distortion" and "phase/frequency distortion," and these do seem a bit of a mouthful for repeated use. And, for the reason just explained, although one of them can be abbreviated to "phase distortion" the other must not be "amplitude distortion." So for the purposes of this article I am going to call the things "a/f.d." and "p/f.d."

The terms thus abbreviated are so precise that they hardly need explanation, but it may be as well just to make sure that we all know what we are talking about.

In such things as sound or vision communicating and reproducing equipment, there should be equal treatment of all the wanted frequencies. For instance, if one assumes that full reproduction of sound necessitates 20 to 20,000 c/s, then a graph of overall amplification or transmission against frequency should be perfectly flat between these limits. One would then be able to say that the a/f.d. was nil. If, however, the graph increasingly sloped downwards above, say, 3,000 c/s the a/f.d. would be "high-fidelity" standards be serious. So would a fall-off below 300 c/s.

## Vector Diagrams Again

In general, a/f.d. is caused by inductance and capacitance, because (unlike resistance) their impedance varies directly or inversely with frequency. In an amplifier, for example, the useful frequency band is often limited at the top by capacitance causing a falling impedance in shunt with the signal path, and at the bottom by capacitance causing a rising impedance in series. It was these simple and common effects that we considered in connection with Nyquist negative-feedback diagrams.\* You may, perhaps, remember how those diagrams showed very clearly that long before shunt capacitance is sufficient to cause an appreciable drop in amplification it has a very pronounced effect on *phase*.

Now, of course, this is not necessarily connected with feedback, and the reason it showed up in Nyquist diagrams is because basically they are vector diagrams. One of the merits of vector diagrams is that they show amplitude changes clearly and phase shifts even more clearly. It happens that the explanation in the December 1955 issue of how a simple Nyquist diagram is formed could be used all over again now for our comparison of a/f.d. and p/f.d. For the sake of any who don't remember, or can't refer to it, here is a summary.

At the upper frequencies the circuit in which a

\*In the December 1955 and January and February 1956 issues.



signal voltage is set up is very often equivalent to that shown in Fig. 1, where a signal current  $I$  flows through a resistance and a capacitance in parallel. The resistance may be that of a coupling resistor in parallel with the resistance of the signal source (a valve, for instance). The capacitance may be due to a capacitor used to suppress frequencies beyond the wanted band, but quite often it is no more than the inevitable stray capacitance of the circuit. The signal voltage is equal to  $I$  multiplied by  $Z$ , the impedance of  $R$  and  $C$  in parallel, and for purposes of comparison  $I$  is assumed to be the same at all frequencies, so the amplitude/frequency characteristic in this case is really the same as a graph of  $Z$  against frequency.

Not only does this particular  $Z$  decrease in magnitude with increasing frequency, but an increasing phase difference develops between the current  $I$  and the voltage. So there are three inter-related quantities—amplitude (or magnitude of  $Z$ , denoted by  $|Z|$ ), phase difference (denoted by  $\phi$ ), and frequency ( $f$ ). A single two-dimensional graph shows only two things at a time, but where sound reproduction is concerned phase difference can be left out of account, because nobody has succeeded in showing that it makes any audible difference—at least, in the sort of situation we are considering now; stereophony is a different matter. So the usual form of graph for the purpose is simply  $|Z|$  (or its equivalent) against  $f$ .

For plotting this graph,  $|Z|$  can be calculated for a number of frequencies from the formula

$$|Z| = \frac{R}{\sqrt{1 + (2\pi fCR)^2}}$$

and the ratio of  $|Z|$  to  $R$  can be expressed either as a fraction or in decibels, as a measure of the a/f.d. But there is a much easier way. At very low frequencies  $(2\pi fCR)^2$  is so small compared with 1 that it can be neglected and so  $|Z|$  is practically equal to  $R$  alone, and the ratio of one to the other is practically 1, so this part of the graph is a horizontal line at 1 (or 0 dB). At very high frequencies, 1 is so small compared with  $(2\pi fCR)^2$  that it can be neglected and so  $|Z|$  is practically

Fig. 2. The decrease in voltage in Fig. 1 varies with frequency as shown by the dotted curve. The two straight lines, meeting at the frequency at which the shunting reactance is equal to the resistance, are a good approximation to the curve at frequencies well off that point, at which the loss is 3 dB.

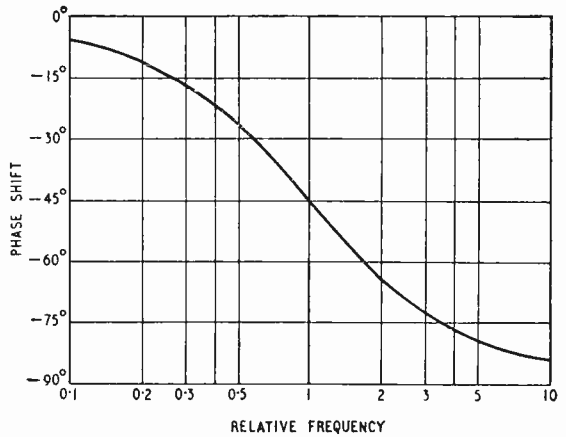
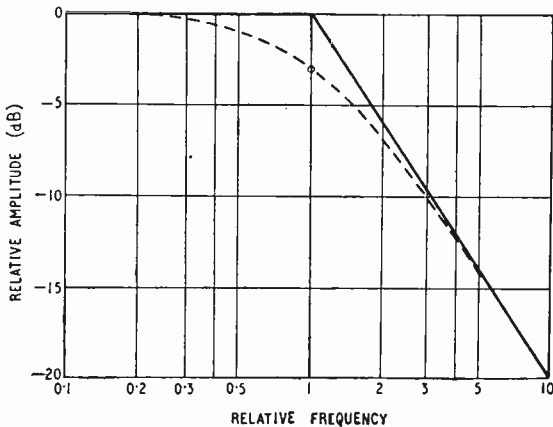

Fig. 3. Phase shift corresponding to amplitude loss shown in Fig. 2.

$1/2\pi fC$ , which is the impedance of  $C$  alone. This is inversely proportional to frequency, so can be represented on the graph by a line that slopes off in such a way as to halve the amplitude for each doubling of the frequency. Halving amplitude is a drop of 6 dB and doubling frequency is a rise of one octave, so the slope of this line is commonly called 6 dB per octave. If a logarithmic frequency scale is used, to match the dB scale which of course is logarithmic, the sloping line is straight, as in Fig. 2. The frequency at which the two straight lines meet is the one at which the impedance of  $C$  is equal to  $R$ ; that is,  $1/2\pi fC = R$ , so  $f = 1/2\pi CR$ . It is what we called the "turning frequency."

### Rapid Plotting

At this particular frequency, neither 1 nor  $(2\pi fCR)^2$  is negligible compared with the other; in fact they are equal. It is here, naturally, that the two-straight-line approximation is furthest from the truth; since  $(2\pi fCR)^2 = 1$ ,  $|Z|/R = 1/\sqrt{2} = 0.707$ , which is  $-3$  on a dB scale. This accurate point can be plotted on the graph, and it gives one a mark for drawing a smooth curve (dotted in Fig. 2) connecting up the two lines.

Note that just as we have "normalized" the amplitude scale by relating  $Z$  to  $R$ , so we have treated the frequency scale, relating all frequencies to the turning frequency. So the Fig. 2 graph holds good for all circuits that can be reduced to Fig. 1; to convert its relative frequency scale to actual frequencies for any particular values of  $C$  and  $R$ , multiply it by  $1/2\pi CR$ .

Precisely the same curve applies when the upper-frequency drop is caused by series inductance instead of shunt capacitance. Because the inductive impedance is  $2\pi fL$  the turning frequency is  $R/2\pi L$ .

The same graph turned around left to right is correct for lower-frequency drop due to series  $C$  or shunt  $L$ , the turning frequencies being calculated in the same way.

It is generally agreed that until a/f.d. amounts to 3 dB it is hardly noticeable, so the effective frequency band of a piece of sound-reproducing equipment is usually reckoned between the upper and lower  $-3$  dB points. If only "single-order"

arrangements like Fig. 1 are responsible, these points are at the two turning frequencies. But in a complete system, of course, there are generally a number of things causing top and bottom cut, and the effective band width is narrower than that for any one of them.

Although the accompanying phase shifts may not matter to the ear, they do matter if negative-feedback is to be used, so it may be necessary to supplement Fig. 2 by a phase/frequency graph. (Just as "amplitude" was to be understood as relative to the amplitude at middle frequencies where there was no a/f.d., so it is for "phase.") The phase angle,  $\phi$ , is the angle whose tangent is the ratio of reactance to shunt reactance, or of series reactance to resistance; so for Fig. 1  $\tan \phi = 2\pi fCR$ . At the turning frequency,  $f = 1/2\pi CR$ , so  $\tan \phi = 1$ , and a table of tangents shows  $\phi$  to be  $45^\circ$ . Strictly speaking it is  $-45^\circ$ , because the phase is lagging. Calculating a few more points to plot, we get Fig. 3.

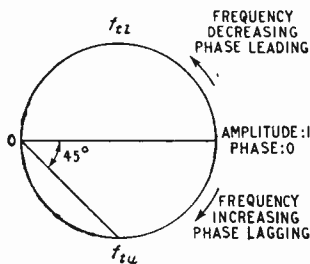

Fig. 4. The circle is the track of the tip of a vector hinged at O, representing signal voltage in a circuit where there is "single-order" cut-off at both high and low frequencies, as the frequency is varied. The vector  $O f_{tU}$  corresponds to the marked point at -3 dB in Fig. 2.

Fig. 5. Waveform (a) is made up of two sine waves of equal amplitude and 3:1 frequency ratio. When the amplification of the higher frequency is reduced relatively to the lower by 7 dB, (b) is the result. The accompanying phase shift further distorts the waveform to (c).

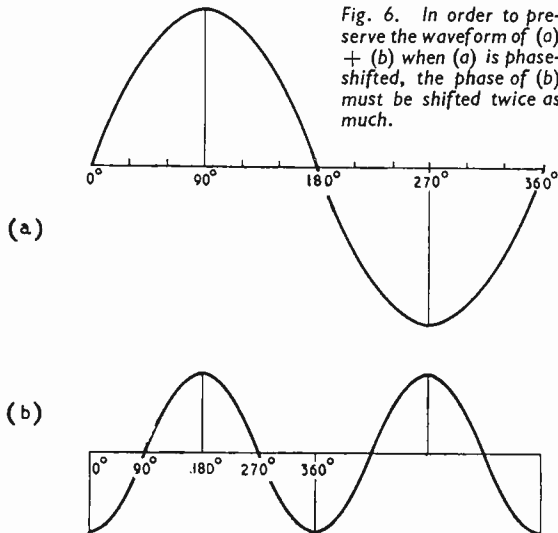
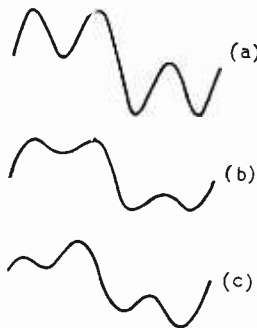

Fig. 6. In order to preserve the waveform of (a) + (b) when (a) is phase-shifted, the phase of (b) must be shifted twice as much.

It serves also for series inductance, but for low-frequency cut the graph must not only be turned left to right but the  $-$  become  $+$ .

These two graphs taken together show that phase starts noticeably sliding down before amplitude (so it is lucky our ears don't detect the phase shift), but for this particular comparison the vector form of graph is neater. Since we have so recently gone fully into this, I'll just show Fig. 4 as a reminder. The only difference between it and those we used in connection with feedback is that because it was negative feedback we were interested in they were upside down. But we still have the familiar circular shape. The "origin" is marked "O," and the horizontal diameter starting from it is the vector representing no distortion. Its length represents the amplitude, taken as 1 for comparison, and the fact that it points at 3 o'clock is the conventional way of showing that its phase angle is zero. The fall-off in amplitude, shown one way in Fig. 2, appears in Fig. 4 as the decreasing length of the vector when its tip moves around the circle towards O, while the phase shift is indicated directly by its change of direction. And we see that the direction changes quite a lot—say  $20^\circ$ —before the shortening is very noticeable even to the eye. By the time it is noticeable to the ear—say  $-3$  dB, at  $f_{tU}$  or  $f_{tL}$  (the upper or lower turning frequencies)—the phase shift amounts to  $45^\circ$ , as we have already seen in Fig. 3.

### Visible Effects

And now, having collected together our tools and reminded ourselves how they are used, we can start on the job.

The first thing to notice, in reviewing a/f.d. and p/f.d., is that neither of them can distort a single-frequency signal. The essence of both kinds of distortion is that they treat different frequencies unequally, and if only one frequency is present there is nothing that can be unequal. So a sinusoidal waveform cannot suffer from a/f.d. or p/f.d.

But if now we put on a very slightly more entertaining programme, say "Cathode Ray's" *Duet in A Flat for Two Audio Signal Generators*, and if at a given moment the soprano generator is playing a note of a frequency specified in Fig. 2 as "3" and the tenor generator is accompanying it on frequency "1," it is clear that there will be distortion, because the relative strengths of the two notes are upset to the extent of 7 dB. If the passage in question were scored for equal intensities from the two instruments\*, the input waveform (assuming zero phase difference at the start) would be as in Fig. 5(a), where one whole cycle is shown. If now the higher tone is reduced by 7 dB the result is Fig. 5(b), which has a markedly different waveform—almost an approximation to a square wave—and distortion can certainly be said to have taken place. But this is not what would be obtained from an actual distorting circuit, for the a/f.d. is inevitably accompanied by p/f.d., with the result shown at (c).

Although (c) looks distinctly different from (b), it would sound just the same. So would waveforms with even more striking visual differences. But for

(Continued on page 191)

\* In "Cathode Ray's" musical works, directions are, of course, given in dB instead of the usual vague terms such as *pp* and *mf*.

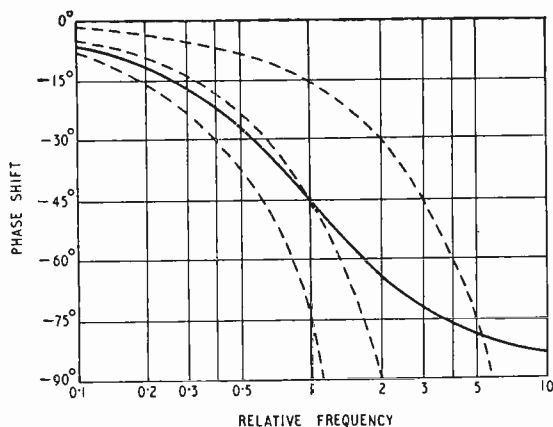

Fig. 7. To the actual phase-shift curve of Fig. 3 are added dotted curves all of which represent zero phase-frequency distortion.

some purposes, notably television, p/f.d. cannot be ignored. So we are going to switch attention from the well-known a/f.d. to the not quite so well-known p/f.d.

Because a/f.d. is shown on an a/f characteristic diagram such as Fig. 2 as departure from the straight and level, one might suppose that the same applied to a p/f diagram and p/f.d. The fact that the sloping p/f curve in Fig. 3 has certainly knocked the shape out of Fig. 5(b) seems to confirm that. And it is obvious that a perfectly flat p/f characteristic at the zero level indicates no p/f distortion; if there were no phase shift of any of the component parts of a waveform, the whole thing would be left where it was. But it is also true that a waveform is not distorted by being shifted *as a whole*. This matches the fact that altering the amplitude as a whole does not distort—otherwise amplification would by definition be distortion! Any number of no-distortion lines can be drawn on an a/f graph; they can be at any level, so long as they *are* level, showing that the amplitude is changed equally at every frequency.

### A Catch

In the same way, presumably, horizontal no-distortion lines can be drawn at any level on a p/f graph, showing that the phase is shifted equally at every frequency? But we presume too much. There is a catch hidden in the word "equally." Fig. 6 will show it more clearly than a lot of explanation. Phase is reckoned in fractions of a cycle, usually in 360ths, commonly called degrees. Waveform (b) is twice the frequency of (a), so has twice as many cycles in a given time, and therefore twice as many degrees. If (b) is added to (a) it sharpens its positive half-cycle and blunts its negative half. Now if (a) is phase-shifted 90° to the left its positive peak is brought to the starting point, and to preserve the same shape wave (b) must be moved to the left an equal *time* interval. But on its phase scale that is 180°. If its *phase* shift were the same as (a)'s its positive peak would not coincide with (a)'s and the composite waveform would be quite different; in a word, it would be *distorted*.

If (b) had been three times the frequency of (a), its phase shift would have had to be three times (a)'s.

On a p/f graph, then, the only no-distortion line

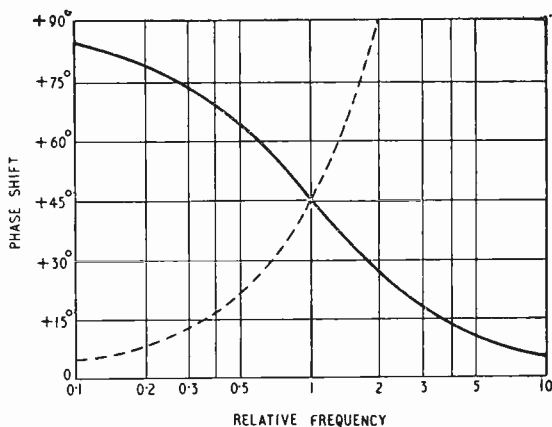

Fig. 8. Whereas the actual phase-lag curve in Fig 7 causes hardly any phase distortion up to the high-frequency cut-off, the phase-lead down to and beyond low-frequency cut-off falls right across the no distortion lines, one of which is shown here.

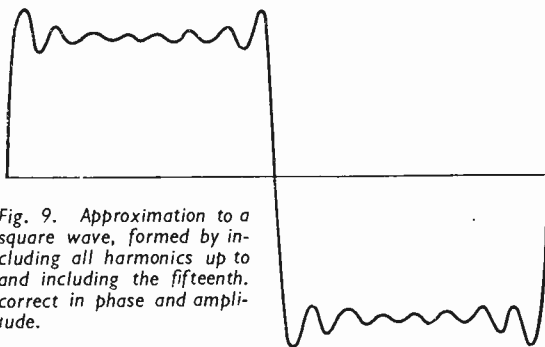

Fig. 9. Approximation to a square wave, formed by including all harmonics up to and including the fifteenth, correct in phase and amplitude.

that is flat is the one at 0°; all the others must indicate phase shifts *proportional to frequency*. If the shift at the reference frequency (1) is 45° as in Fig. 3, at twice the frequency it must be 90°; at four times, 180°; and so on. Such a curve does in fact follow Fig. 3 fairly closely up to 45° (Fig. 7) although beyond that it goes right off. So although the amount of a/f.d. up to that point, which is usually tolerated, is accompanied by a relatively large amount of phase *shift*, it is not a large amount of phase *distortion*. It looks as if p/f.d. is a negligible factor in the distortion of any waveform by a top-cut circuit having a turning frequency no lower than the highest significant frequency in the waveform; practically all the distortion is a/f.d. That does not, of course, mean that the phase shift of the waveform as a whole can always be ignored, but just that it does not appreciably affect the wave shape.

Having previously noted the mirror relationship between top-cut and bottom-cut circuits, one may perhaps suggest that the same kind of principle applies also to bottom-cut circuits. But no! This is where the symmetry breaks down. As Fig. 8 shows, the leading phase-shift curve corresponding to the lagging curve of Fig. 3 could hardly differ more from the dotted line, which is the no-p/f.d. curve passing through the 45° point. We may expect, then, that visible distortion at the low-frequency end of the band will be worse than at the high-frequency end. Whereas at the h.f. end virtually only the a/f.d. has any effect, at the l.f. end there is a/f.d. plus probably even greater p/f.d.

Just how it works out in practice depends, of course, on the original waveform of the signal, because on that depend the frequencies present and their relative amplitudes and phases. Perhaps the most important waveform after the sinusoid is the square wave. Moreover, distortion of it is easy to see. So it should be a good example for comparing the effects of l.f. and h.f. distortion. For some purposes it is essential to keep its front nearly vertical or its top nearly horizontal, or both. It contains odd harmonics only, up to infinity if the squareness is to be perfect. The third harmonic is one-third the amplitude of the fundamental, the fifth one-fifth, and so on, so the absence of the very high ones is not conspicuous. All the harmonics start off in phase, in order to provide the infinitely steep rise and fall.

### Fourier or Oscilloscope

If you are looking for something to while away a very long time (or something to do with your new electronic computer) you can try making up the square-wave recipe just given, adding in harmonics until the result is square enough. Myself, I have never got beyond the fifteenth, and that yields a rather poor apology for a square wave, with a lot of ripples on the supposedly flat top (Fig. 9). One can then (if still in the game) alter the amplitudes and phases in accordance with any desired distorting circuit and note results. Besides being liable to revive the mathematicians' riot that broke out on the appearance last September of "Fourier—Fact or Fiction?" this suggestion will no doubt be rejected as intolerably tedious or expensive—unless the fascination of it gets you.

There are two simpler methods. One is to consider the distorting circuit as a capacitance charging or discharging through a resistance. The other

Fig. 11. Oscillograms of square waves distorted by the conditions shown in Fig. 10. Although Fig. 10(a) would suggest much worse distortion than (b), the relatively serious effect of phase-shift in (b) proves decisive.

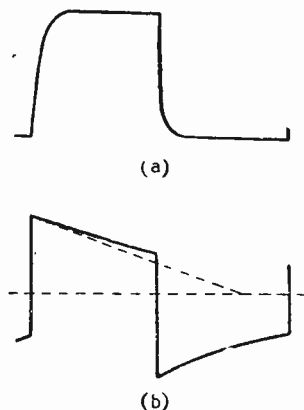

is to connect a square-wave generator to the appropriate distorting circuit and observe the output on an oscilloscope.

Fig. 10 shows the basis of the first comparison we shall make. In each case the fundamental, represented by the tallest vertical line, is on the safe side of the turning frequency (1 on the scale) by a 5 to 1 margin. The attenuation and phase shift are therefore the same in both, as regards the fundamental. But as regards the whole series of frequencies in the square wave, the odds appear to be heavily against it in the top-cut case (a), because all the harmonics are lower down the curve than the fundamental; in fact, all except the third and fifth are right outside the accepted frequency band, as usually defined. On the other hand, in (b) all the harmonics are on the safe side of the fundamental, and might be expected to be almost free from distortion.

How does it actually work out? Fig. 11 shows what the oscilloscope reveals when tests are made under the conditions just described. Waveform (a) corresponds to Fig. 10(a), and (b) to 10(b). There is no doubt that the l.f. distortion (b), though under apparently much more favourable conditions, is more visible than the h.f. Which was more troublesome in practice would depend on whether the need was for a steep front or a flat top. In (a), the distortion is due mainly to the weakening of the harmonics, which reduces the steepness of the wave-front. As we saw in Fig. 7, there is very little relative phase shift except at frequencies which are barely represented in the output. In (b), on the other hand, a/f. distortion is almost negligible, and the pronounced tilting of the horizontal parts of the square wave is due almost entirely to the phase-shift of the fundamental relative to the harmonics. An approximation to it can be obtained by adding to a true square wave the difference between a sine wave starting at  $0^\circ$  and one starting at  $11.3^\circ$ , both of them having an amplitude  $4/\pi$  times that of the square wave.

### Square-wave Testing

However fascinating Monsieur Fourier may be, there is no doubt that for square waves the charging capacitor approach is simpler. According to it, the blunting of the wave-front in Fig. 11(a) is caused by the shunt capacitance in Fig. 1 having to charge up before the full voltage can be established across the resistance. The theory of the thing shows that if the rate at which C began to charge were kept up the charging would be completed in CR seconds. Now Fig. 10(a) shows the square-wave frequency  $f_s$  to be 0.2 times the turning frequency  $f_t$ , which we

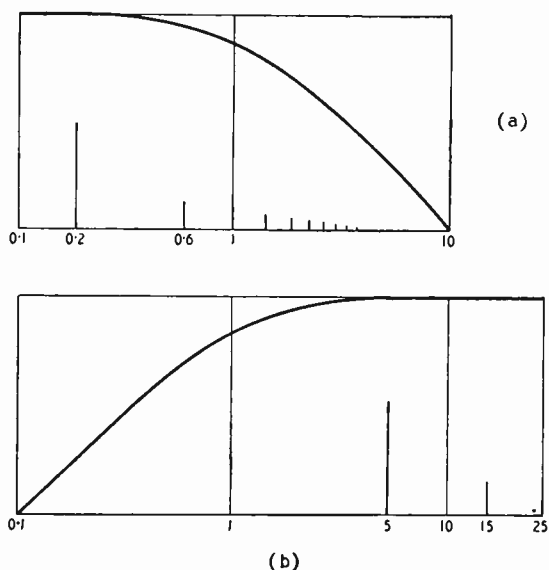

Fig. 10. These two diagrams show the relative amplitudes and frequencies of the first few components of a square wave, in relation to (a) high and (b) low frequency cut-off curves. In (a) the fundamental of the square-wave is one-fifth the cut-off frequency ( $=.1$ ) and in (b) it is five times, giving the same reduction in amplitude.

know is  $1/2\pi CR$ . Therefore,  $CR$  is  $0.2/2\pi f_s$ , or  $0.2/2\pi$  times the duration of one square-wave cycle, or  $0.2/\pi$  or 0.064 times the duration of half a cycle. In other words, if the beginning of the upward rise in Fig. 11(a) were produced until it hit the original perfect flat top, it would do so only about one-sixteenth of the way along it.

The sloping top in Fig. 11(b) is caused by capacitance in series. Ideally, it would not charge at all during half a cycle, but because it is not infinitely great it must charge somewhat. It begins at a rate which, if kept up, would complete the job in  $CR$  seconds. Fig. 10(b) shows that the square-wave frequency  $f_s$  is 5 times the turning frequency,  $1/2\pi CR$ . Therefore,  $CR$  is  $5/2\pi f_s$ , or  $5/2\pi$  or 0.8 times one cycle. So if the starting slope had continued it would have reached the zero line in less than a cycle, as shown dotted in Fig. 11(b).

This, then, is a very sensitive test of low-frequency loss. By adjusting the oscilloscope so that the square waves are very narrow, it is quite easy to detect a sloping top when the turning frequency is as much as 50 times lower than the square-wave frequency used for testing. In fact, by using a single test frequency of, say, 1,500 c/s one can detect turning

frequencies of both 30 c/s and 20,000 c/s, and thereby estimate the effective bandwidth of an audio amplifier. Of course, in complete amplifiers with more than one stage the relationships between a/f and p/f characteristics are more complicated (as we saw in the January issue), but nevertheless the square-wave test at a single frequency—or at the most two frequencies—gives one some idea of the bandwidth, and at the same time shows up any resonances, as ripples on the flat top, and enables one to judge their frequency and damping.

Another thing that emerges from our study is that if we want to preserve a flat top to a square wave-form it is certainly not enough to make sure that it is just on the right side of what is usually reckoned as the cut-off frequency. It looks as if, for a 50 c/s square wave, the cut-off frequency ought to be not higher than 0.5 c/s. In other words, the coupling capacitor must be large enough for its reactance to be only about one-hundredth the resistance fed through it—say  $3\mu F$  for  $100k\Omega$ , instead of the  $0.1\mu F$  that would do nicely for sine waves. However, if one doesn't like this, alternative dodges can sometimes be used, such as low-frequency boost circuits. But that is another story.

## V. H. F. at SEA

By CAPT. F. J. WYLIE,\* R.N. (Retd.)

### PROPOSALS FOR MARINE RADIO-TELEPHONE SERVICE

**TOWARDS** the end of last year an international conference was held at Gothenburg, Sweden, to improve marine radio-telephone communication in the Baltic and North Sea. The main work concerned the effective use of the frequency band 1,605 to 3,905 kc/s, which includes the international distress and calling frequency (2,182 kc/s), and an agreement was unanimously adopted by the 13 participating countries. During the conference an informal meeting, attended by all delegates, was held to discuss the use of v.h.f. for the marine mobile services and our contributor, who was an observer for the International Chamber of Shipping, here summarizes the results of the discussions at Gothenburg.

**S**HIPS of any flag may communicate with each other and with the coast stations of other countries without any difficulty using standardized m.f. and h.f. equipment. With v.h.f. radio-telephony, the situation is very different; services like those offered in the other bands do not exist and the majority of the few ships which do carry v.h.f. equipment, do so for communication within their own companies' networks. The thousands of deep-sea ships which are potential beneficiaries of the advantages of short-range radio-telephony are not equipped because no such internationally agreed service is offered in the ports and on the coasts of the world.

For v.h.f. to be an economic proposition for ships, it is necessary to use broad-band equipment, with crystal switching to change the frequency. This means that a single unit of equipment would have to cover a band of about 2 Mc/s or, preferably, 1.5 Mc/s. More complicated equipment may, of course, be built up of units which together cover a much wider band. Further, to achieve intelligible speech between stations, it is necessary to specify with considerable accuracy a number of technical parameters for the equipment. At the present time, as far as international usage is concerned, no frequency band is defined and no technical characteristics have been agreed. Added to these technical barriers is the lack of international collaboration between governments and the other interested parties.

The shipowners' Radio Advisory Service in the U.K. has been endeavouring for some years to stimulate interest in this matter through both national and international channels. Due in considerable measure to these efforts, opportunity was taken by the delegations at the Baltic and North Sea Radio-telephone (2 Mc/s) Conference at Gothenburg to discuss informally the basic requirements of an international maritime v.h.f. service. Without difficulty, informal agreement was reached on frequency bands (156.0-158.025 and 160.525-162.525), the type of modulation (f.m.), channel spacing† and on a tentative frequency plan giving in general terms the channel

\* Radio Advisory Service of the Chamber of Shipping and the Liverpool Steam Ship Owners' Association.

† Initially 100 kc/s, but it is recommended that equipment should be designed for 50-kc/s channel spacing.

Mc/s	Nature of communications
156.1*	Intership, harbour and docking
156.2*	Intership, harbour and docking
156.3†	Intership (First choice)
156.4*	Intership, harbour and docking
156.5*	Intership, harbour and docking
156.6†	Port operations (First choice)
156.7*	Intership, harbour and docking
156.8†	Safety and calling
156.9*; 161.4*	Harbour and docking or public correspondence
157.0*; 161.5*	Harbour and docking or public correspondence
157.1*; 161.6*	Harbour and docking or public correspondence
157.2*; 161.7*	Harbour and docking or public correspondence
157.3; 161.8	Public correspondence (Second choice)
157.4; 161.9	Public correspondence (First choice)

\* Single or double frequency operation.

† Single frequency operation only.

allocations (see Table). It is to be hoped that at the VIIIth Plenary Assembly of the C.C.I.R. in Warsaw this summer, there will be equally little difficulty in settling all the other vital parameters.

If this desirable situation is reached, there will then be known all the essential factors for the design of ships' v.h.f. equipment. It then remains for legislation to be made on the facilities to be provided by v.h.f. Administrations will have to assign frequencies and establish public correspondence services and port authorities will (it is to be hoped) offer pilotage, navigational and other services on v.h.f. in the ports of the world.

Perhaps the most vital point which will still remain to be established, is the number of channels which will be needed to operate the international facilities to be offered. One of the principal factors in the cost of the ship's equipment will be the number of channels it must cover. It will be useless to say that the ship should be prepared to use any of the 30 channels made available in a 1.5 Mc/s waveband with 50 kc/s spacing, when the maximum number which any port uses may be found to be 10. On the other hand, it will be equally frustrating for the shipowner to provide his ships with 6-channel equipment to find that the average port uses 12 channels.

This rather simple arithmetic is complicated by the fact that the magic number, when it has been found and agreed, will not only describe the best number of channels for a ship's equipment but will also define the number for which all countries will need to assign the same frequencies. The ideal to be aimed at is that a ship of any nationality should be able to close any coast and enter any port and take advantage of any v.h.f. radio-telephone service available, using equipment offered at a reasonable price because it needs to cover only, say, 8 to 12 channels.

The kind of communications in mind are with the pilot vessel, the port radar station, the port traffic authority, the berthing or docking officer and, through public correspondence, perhaps, to owner or agent, fire brigade or police. This is all "ship's business." It is doubtful whether the large volume of passenger radio-telephone traffic could or should be carried on this basic equipment. The peak de-

mands for "ship's business" and passenger calls will synchronize and so must be operated simultaneously in different bands.

It is abundantly clear, first, that the subject of international maritime v.h.f. contains a large number of unsolved problems, most of which will concern at least three of the four main interested parties and, secondly, that the haphazard development from small beginnings, which characterized the growth of the m.f. and h.f. systems, will not be healthy for v.h.f. It is hoped that the Gothenburg informal agreement has set the ball rolling, nationally and internationally, and that by the time the C.C.I.R. has settled the technical parameters, the much needed collaboration between administrations, manufacturers and users will be manifest.

## Professional Recording Methods

IN a lecture to the British Sound Recording Association recently W. S. Barrell, B.Sc., of E.M.I. Recording Studios, outlined the development of professional disc recording during the past 30 years and contrasted the heavy gravity-operated direct-recording machines using wax masters with the relatively portable magnetic recorders with which tape masters are now produced. In his view the facility with which these magnetic tapes can be cut and edited has not proved an unmixed blessing. Modern artists seem to have lost the ability to go through even a 4½-minute session without coughing or rustling—an essential qualification for recording in the days of the wax disc.

Lacquer discs are now used in the first step from tape to the record stamper, and an entirely new disc recorder has replaced the older one, using a single-turn moving-coil cutter, which had given long years of service with wax. The new machine incorporates an automatic variable groove-spacing device, and is push-button operated throughout, including the selection of turntable speed and operation of the run-off groove mechanism.

Mr. Barrell made some interesting comments on studio technique in general and expressed the view that no single microphone had so far proved itself suitable for all types of recording. E.M.I. chose the appropriate instrument for any given recording from a range of different types—all with similar measured characteristics. In his view the old E.M.I. (Blumlein) moving-coil microphone was still the best for recording the piano.

## Ionic Fire Alarm

ONE disadvantage of conventional fire indicators and alarms, which depend on a rise of temperature for their operation, is the time delay before the critical temperature is reached, particularly if the indicating device is some distance from the original seat of the fire.

A new method due to E. Meili depends on the reduction by smoke particles and other products of combustion of the current induced in an ionization chamber by a minute radioactive source. To compensate for normal variations due to atmospheric pressure and temperature a second ionization chamber, to which smoke cannot enter, is connected in series with the first to form a potential divider. The change in potential due to smoke is applied to a cold cathode gas discharge triode which operates a relay.

The manufacturers of the system in this country are The Minerva Detector Company, Ltd., Red Lion Street, Richmond, Surrey.

# French Components Show

**T**HE accompanying photographs show a few of the more interesting items displayed at the Parc des Expositions, Paris, where the 19th exhibition of radio components, valves, accessories and measuring instruments was held this year. Organized by the Syndicat des Industries de Pièces Détachées et Accessoires Radioélectriques et Electroniques, the show as a whole was notable for being well laid out and decorated, with plenty of space between the stands, and for the novel feature of having a programme of lectures running during exhibition hours.

It was definitely a French national exhibition—there being practically no foreign products on show—and the accent tended to be on “professional” components and accessories, and things designed to satisfy military specifications. However, there was a noticeable increase in new components for f.m. receivers, for multi-channel television sets and for high-quality sound reproduction equipment. Printed

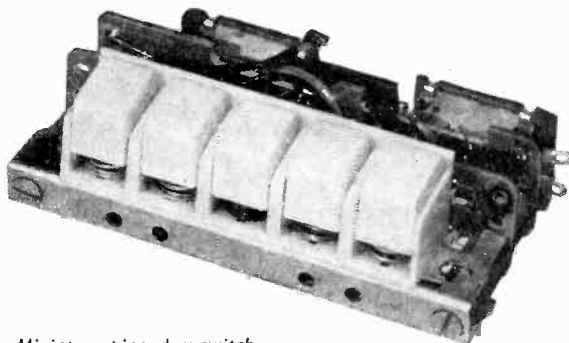

Miniature piano-key switch shown by Op.alix.

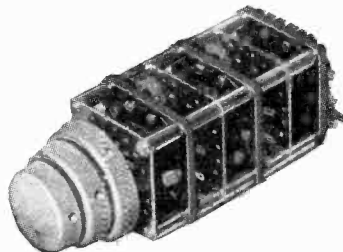

Triple coaxial rotary switch made by Dyna.



Left: Klystron of 4 megawatts output power produced, mainly for use in linear accelerators, by Compagnie Générale de T.S.F. The height of the valve is about 3 feet.

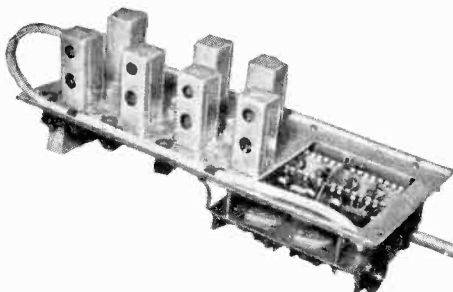

Multi-channel television receiver “front-end” shown by Cicor.



Left: Microphone incorporating a transistor pre-amplifier, shown by Lemonne.

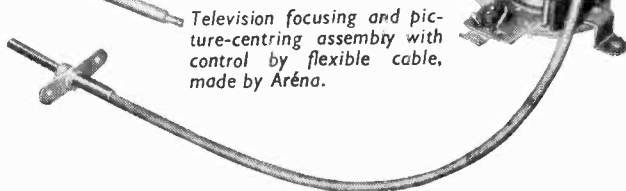

Television focusing and picture-centring assembly with control by flexible cable, made by Aréna.



Left: A miniature gramophone turntable (45 r.p.m.) made by Eden-Dentzer. Right: The same equipment in a small portable record player by Clement, using a transistor amplifier (OC70, OC71 and two OC72s) and powered by four 1.5-V torch batteries. The size of the exhibits can be seen from the copy of our French contemporary, *Toute La Radio*, underneath.

Right: An oscilloscope made by Leres. The bandwidth of the Y amplifier is 60 Mc. s.



circuits were very much in evidence and also miniature components for use with transistors. The outstandingly original development work done by the French on velocity-modulation valves for s.h.f. was represented by new types of "Carcinotrons" (backward-wave oscillators) for operation in radar equipment.

The subjects of the lectures (18 in all) gave additional emphasis to the "non-entertainment" tone of

the exhibition—magnetic recording in the field of information; new forms of construction for electronic circuits; magnetic materials (in particular, ferrites); semi-conductor devices and their influence on component design; methods of control in the manufacture of components. The final address, by an official of the industry, gave an account of the work which is being done in France to establish proper specifications for radio components.

## Instructional Films on Waveguides

### Colour Animation as an Aid to Teaching

ANYONE who has ever attempted to explain the principles of waveguides will hardly need convincing of the value of animated film as a teaching aid. Without movement, the most skilfully drawn diagrams call for a considerable effort of imagination on the part of the trainee, and the instructor is not always fortunate enough to be able to count on this. The appearance of a set of five films developing the subject clearly and logically from the basic principles of electric and magnetic fields is therefore most welcome. They are 16-mm sound films in colour—practically essential for distinguishing the fields—produced by Science Films, Ltd., for the Royal Air Force, but are available to the other Services and to technical colleges, etc.; inquiries should be addressed to Air Ministry (S.T.4), London, S.W.1.

Each film runs for about 20 minutes, and is intended to be shown at an appropriate point in an extended course of instruction. Because of the heavy cost of animated film in colour, they are highly concentrated and need to be supplemented by a considerable amount of classwork; for the same reason it would be most desirable for trainees to see each one at least twice.

Part I ("Guiding Electromagnetic Waves") starts from the propagation of transverse electromagnetic waves along two-conductor transmission lines, and indicates the desirability, for microwaves, of reducing losses by removing the inner conductor of a coaxial cable, with its solid supports; but propagation of such waves then becomes impossible owing to boundary conditions being wrong.

Part II ("Bouncing Waves") continues the story by showing that the introduction of a longitudinal component of either electric or magnetic field, so that the waves are reflected alternately from top and bottom of the guide, sets up acceptable boundary conditions. The resulting field patterns and their motions are then developed. This is undoubtedly the key film in the series and the one in which animation is most helpful.

Part III ("E and H Waves, Launchers and Slots"). From the  $H_{01}$  rectangular mode in Part II, the other modes are distinguished, and factors governing the choice of waveguide dimensions are explained. Animation again results in a particularly effective treatment of launching probes. Wall currents are considered, and their bearing on radiating and non-radiating slots.

Part IV ("Resonant Cavities, Joints and Stubs"). The production of standing waves by reflection from a closed end of a guide is shown by superimposing animated diagrams, and the length of guide is suc-

cessively reduced until it is no more than a resonant cavity. Next come the techniques necessary for feeding a rotating aerial—choke joint, undesired-mode suppression, etc.—and series and shunt stubs are explained by analogy with transmission lines.

Part V ("Iris and other Matching Devices; Common T and R Systems"). This film falls into three sections: the first, dealing with irises, screws and dielectric rod matching devices, consists largely of pictures of the devices included, with little animation or development from basic principles; the second makes better use of the medium in explaining common T and R systems; and the third is a recapitulation of the four preceding films.

Throughout, particular care is taken to link the theoretical explanations with practical application in radar installations. The tempo of the exposition seems to vary somewhat from section to section, but this—and the impression that fields consist of lines—can no doubt be corrected by the instructor. There are one or two slight inaccuracies in the delineation of the fields. On the whole, though, all concerned in the production of these films are to be congratulated on an excellent job and a valuable addition to teaching facilities.

M. G. S.

### A.R.R.L. Handbook

THE 33rd edition of The Radio Amateur's Handbook now available has been considerably revised and its 26 chapters reflect the most up-to-date techniques in amateur radio communication and frequency measurements. Some of the new equipment has a particular appeal to the beginner, but this is not at the expense of the advanced amateur as space has been made for it by omitting obsolete designs.

The tables of valve and semi-conductor data cover 39 pages and are right up to date. Much of this information is not available elsewhere in such easily assimilated form.

Compiled by the headquarters staff of the American Radio Relay League the handbook contains 608 pages of text, charts and illustrations, plus a 13-page index. It costs 30s (32s by post) in the U.K. and is obtainable from the Radio Society of Great Britain, New Ruskin House, Little Russell Street, London, W.C.1, or from The Modern Book Co., 19-23, Praed Street, Paddington, London, W.C.1.

### "Magnetic Tape Amplifier"

In Fig. 1, p. 120, of the March issue, the lower end of P3 should be joined to the junction of C14 and R13; on p. 122, col. 2, line 52, R43 should be R38; on p. 123, col. 2, line 10, R4 should be R5 and on p. 124, col. 2, line 27, the series grid resistor and not R9 should be 1 M $\Omega$ .



## APRIL MEETINGS

### LONDON

4th. I.E.E.—“The Crystal Palace television transmitting station” by F. C. McLean, A. N. Thomas and R. A. Rowden; “The Broadcasting House—Crystal Palace television link” by Dr. A. R. A. Rendall and S. H. Padel; and “Band I television transmitter design with particular reference to the transmitters at Crystal Palace” by V. J. Cooper and W. J. Morcom at 6.15 at Savoy Place, W.C.2.

6th. Brit.I.R.E.—Discussion on “The importance of visual aids in the teaching of advanced radio and electronic engineering” opened by R. H. Garner at 6.30 at the School of Hygiene and Tropical Medicine, Keppel Street, W.C.1.

6th. Television Society.—“Television transmitter design” by V. J. Cooper (Marconi's) at 7.0 at 164 Shaftesbury Avenue, W.C.2.

9th-14th. I.E.E.—Convention on digital-computer techniques at Savoy Place, W.C.2.

19th. Television Society.—“Recent progress in transistors with reference to television” by J. H. Barry, A. E. Jackets and D. D. Jones (G.E.C. Research) at 7.0 at 164 Shaftesbury Avenue, W.C.2.

20th. B.S.R.A.—“Magnetic tape as a control medium for machine tools and allied equipment” by D. T. N. Williamson at 7.15 at the Royal Society of Arts, John Adam Street, W.C.2.

23rd. I.E.E.—“Automatic assembly systems for electronic equipment” by G. W. A. Dummer at 5.30 at Savoy Place, W.C.2.

25th. Brit.I.R.E.—“Radio and television interference—its growth and effects” by M. Smith at 6.30 at the London School of Hygiene and Tropical Medicine, Keppel Street, W.C.1.

26th. I.E.E.—“Radio astronomy” by Professor A. C. B. Lovell at 5.30 at Savoy Place, W.C.2.

### BIRMINGHAM

23rd. I.E.E.—Annual general meet-

ing of South Midland Radio Group, followed by “F.M. broadcasting and reception” by H. E. Farrow at 6.0 at the James Watt Memorial Institute, Great Charles Street.

### BRISTOL

10th. Television Society.—“Oscilloscopes” by T. S. Whish at 7.30 at the Hawthorns Hotel, Woodland Road.

### GLASGOW

11th. Brit.I.R.E.—“Glasgow University synchrotron: its principles and application” at 7.0 at the University's Department of Natural Philosophy.

### MALVERN

9th. I.E.E.—Informal discussion on technical education to be opened by Dr. K. R. Sturley and C. F. Partridge at 7.30 at the Winter Gardens.

### MANCHESTER

5th. Brit.I.R.E.—“Design of an underwater television camera” by D. R. Coleman and D. Allanson at 6.30 at Reynolds Hall, College of Technology, Sackville Street.

11th. Television Society.—“Cathode-ray tubes for television” by M. D. Dudley (Ferranti) at 7.30 at the College of Technology.

18th. Television Society.—“Some problems of a band-sharing colour television system” by A. V. Lord (B.B.C. Research) at 7.30 at the College of Technology.

### PORTSMOUTH

11th. I.E.E.—Annual general meeting of Southern Centre followed by discussion on “Soldered joints” opened by W. Ford, at 6.30 at the College of Technology Extension, Anglesea Road.

### WEYMOUTH

13th. I.E.E.—“Application of electronics to accountancy” by W. Woods-Hill at 6.30 at the South Dorset Technical College.

## MAY MEETINGS

### LONDON

9th. I.E.E.—“Time sharing as a basis for electronic telephone switching: a switched highways system” by L. R. F. Harris at 5.30 at Savoy Place, W.C.2.

9th. Royal Society of Arts.—“Automation” by the Right Hon. the Earl of Halsbury (National Research Development Corporation) at 2.30 at John Adam Street, W.C.2.

14th. I.E.E.—Discussion on “An elementary presentation of the principles of magnetism and electromagnetic induction, with demonstrations” opened by Professor K. A. Hayes at 6.0 at Savoy Place, W.C.2.

16th. Royal Society of Arts.—“Electronic photography” by Commander C. G. Mayer (R.C.A.) at 2.30 at John Adam Street, W.C.2.

23rd. Brit.I.R.E.—“The measurement of the velocity of ‘light’ by electronic methods” by Dr. K. Froome at 6.30 at the School of Hygiene and Tropical Medicine, Keppel Street, W.C.1.

25th. B.S.R.A.—“Description and demonstration of the B.B.C. (Type DRD 5) fine groove reproducing desk”

by H. J. Houlgate, followed by a recital of unusual recordings from the B.B.C. archives presented by T. H. Eckersley at 7.15 at the Royal Society of Arts, John Adam Street, W.C.2.

### BIRMINGHAM

2nd. Junior Institution of Engineers.—“Electronic control—the new power in industry” by J. A. Sargrove (Automation Consultants and Associates) at 7.0 at the James Watt Memorial Institute, Great Charles Street.

### GLASGOW

2nd. I.E.E.—“The search for and salvage of the Comet aircraft near Elba” by Commander C. G. Forsberg and G. G. MacNeice at 7.0 at the Institution of Engineers and Shipbuilders, 39 Elmbank Crescent.

### STAFFORD

4th. I.E.E.—“Germanium and silicon power rectifiers” by T. H. Kinman, G. A. Carrick, R. G. Hibberd and A. J. Blundell at 7.0 at the Technical College.

### TORQUAY

10th. I.E.E.—“Radio astronomy” by A. B. Thomas at 3.0 at the Electrical Hall.



In these days, when engineers' time is so valuable, absolute reliability of equipment is an essential in a Sound installation. That is why TRIX equipment is being chosen by discriminating engineers the world over for their Sound requirements. You can do no better than to specify TRIX.



**MODEL T. 103**

High-fidelity Amplifier with numerous applications. Four inputs to suit magnetic or crystal pickups and radio or other input with appropriate selector switch. Outputs for low impedance speakers and 100 v-line. Price £26.10.0.



**MODEL G7871**

High-grade moving coil Microphone of excellent frequency response, substantially level between 50 and 8,000 c.p.s. Satin-chrome finish. Mic Head (G7871/A)

£7 10 0  
With additional switchbox (as illustrated) ... £8 8 0



**THE TRIX ELECTRICAL CO. LTD.**  
MAPLE PLACE, TOTTENHAM COURT ROAD,  
LONDON, W.1.

Tel.: MUS. 5817. Gram: Trixadio Wesdo, London

# RANDOM RADIATIONS

By "DIALLIST"

## Aerial Adventures

I LEARN from readers writing in response to my request for information on f.m. and television reception that a variety of v.h.f. signals are being received on all kinds of apparently quite unsuitable aerials. Good f.m. reception from Pontop Pike on a channel-5 television aerial is more or less commonplace, and at greater ranges than I'd expected. Reports are reaching me of good signals from the channel-8 Lichfield I.T.A. transmitter received on channel-4 Sutton Coldfield aerials. That's not, perhaps, very surprising. The mid-frequency of channel 4 is 60Mc/s and that of channel 8 is 188Mc/s—very nearly an exact multiple. And though the London I.T.A.'s mid-frequency of 193Mc/s is much further from being an exact multiple of the B.B.C.'s 43.5Mc/s, a good many living in the London area tell me that they receive the Band III programmes quite happily on their Band I aerials. A Brentwood reader has outdone the lot by receiving the sound part of the vertically polarized I.T.A. transmissions on his horizontal Wrotham aerial! As I said, a month or two since, queer things can happen to the

polarization of these waves. Reverting to Band III reception on Band I aerials, it'll be interesting to hear in due course how those using Holme Moss aerials (mid-frequency 50Mc/s) get on with Winter Hill (mid-frequency 193Mc/s). They should manage pretty well at short-ish ranges, I think.

## A Crying Need

A PROBLEM that should be tackled firmly—and right speedily—by the radio industry is that of radiation from the line timebases of television receivers. Quite apart from its effects on other TV sets, this radiation is responsible for more than 10 per cent of the cases of interference with ordinary sound reception investigated by G.P.O. engineers. The radiation takes place during the line flyback. No visible interference occurs in one's own set, since the brightness is (or should be) below black level at the time. Nor do neighbouring sets normally affect each other if they are tuned to the same transmitter; the flyback occurs at the same instant in all of them and all are then blacked out. But matters are very different if one viewer is watching a B.B.C. pro-

gramme and a neighbour switches to the I.T.A. station. The flybacks then occur at different times and one far-too-common result is the appearance of a vertical bar on the screen.

## No Half-measures

It's no good trying to find palliatives. So long as strong radiation takes place from the line timebase, interference between TV receivers tuned to different stations is bound to be experienced. Even if the two stations used the same aerial mast and a common master scanning generator, there'd still be trouble. What, for instance, would happen if the B.B.C. station were relaying a distant outside broadcast and by means of "Genlock" had tied its waveform generators to the O.B. apparatus? The evil will have to be tackled at its roots and means found of reducing the radiation to harmless proportions. One thing that surprises me is that I don't recall having seen in any American publication, technical or lay, reference to line timebase radiation interference despite the variety of programmes (I suppose I ought to write "programs"! ) radiated in the big towns. Is one wrong in concluding that American TV set manufacturers have found ways of limiting radiation during the line flyback to something quite innocuous?

## Reduced Handyman Outfit

DURING the years in which I lived at no great distance from London I was able to build up a combined lab-workshop so well found that it contained a useful selection of the instruments and the tools needed for dealing with receiver construction, tests, experiments and repairs, as well as with the domestic jobs that come the way nowadays of anyone who is (or thinks he is) any kind of handyman. And then fate decided that I should cease to be a householder and should be on my rather lonely own as the tenant of part of someone else's house. It was clearly impossible to keep the entire contents of the lab-workshop, for there'd be nowhere to put them or use them. I wonder if, in a similar quandary, you'd have come to the decisions



### " WIRELESS WORLD " PUBLICATIONS

	Net Price	By Post
SECOND THOUGHTS ON RADIO THEORY. " Cathode Ray " of <i>Wireless World</i> ... ..	25/-	26/2
GUIDE TO BROADCASTING STATIONS 1955-56. Compiled by <i>Wireless World</i> ... ..	2/6	2/10
WIRELESS WORLD F.M. TUNER. S. W. Amos, B.Sc. (Hons.), A.M.I.E.E., and G. G. Johnstone, B.Sc. (Hons.) ... ..	2/-	2/3
RADIO LABORATORY HANDBOOK. M. G. Scroggie, B.Sc., M.I.E.E. 6th Edition ... ..	25/-	26/5
STUDIO ENGINEERING FOR SOUND BROADCASTING. B.B.C. Engineering Training Manual by members of the B.B.C. Engineering Division. General Editor J. W. Godfrey. ... ..	25/-	25/11
INTRODUCTION TO VALVES. R. W. Hallows, M.A. (Cantab.), M.I.E.E., and H. K. Milward, B.Sc. (Lond.), A.M.I.E.E. ... ..	8/6	9/2
RADIO INTERFERENCE SUPPRESSION: As Applied to Radio and Television Reception. G. L. Stephens, A.M.I.E.E. 2nd Edition ... ..	10/6	11/1
SOUND RECORDING AND REPRODUCTION. A B.B.C. Engineering Training Manual. J. W. Godfrey and S. W. Amos, B.Sc. (Hons.), A.M.I.E.E. ... ..	30/-	31/-
ADVANCED THEORY OF WAVEGUIDES. L. Lewin ... ..	30/-	30/10
FOUNDATIONS OF WIRELESS. M. G. Scroggie, B.Sc., M.I.E.E. 5th Edition ... ..	12/6	13/6

A complete list of books is available on application.

Obtainable from all leading booksellers or from

ILIFFE & SONS LTD., Dorset House, Stamford Street, London, S.E.1.

that I made. My lathe, drilling machine, oscilloscope and valve-voltmeter have fallen by the way. Good homes, I may mention, have been found for all of them. All that I've kept is a useful selection of small tools and appliances. Among these are two high-quality multi-range measuring instruments, an electric drill with a complete outfit of Morse "twists" from 0 to 60, a drill-plate, assorted pliers, various files, a wire-stripper, box spanners and screwdrivers ranging from the jeweller's to one with a blade  $\frac{3}{16}$  in wide. So far, these have helped to do all the necessary jobs. Can you suggest any omission?

### Modernization

IN my new home I've had all the electric wiring done, or re-done (and some of it badly needed that!) on the ring-main system with the latest kind of 13-ampere outlets for anything that is meant to be plugged into a socket. I'm delighted with the simplicity, the neatness and the safety of the whole installation. Particularly am I pleased with the plugs (3-pin, of course), which contain not only the fuse appropriate for the apparatus to which they're attached—3A, 7A or 13A, as the case may be—but also a small, but quite effective, switch in the phase lead. It breaks all loads up to 13A without any fuss and you can be sure that apparatus left plugged in but switched off is in a perfectly safe condition. Both my sound and TV receivers have their plugs (fused 3A) so connected that the chassis are neutral. When I switch off at the plug or at the set I know that they're electrically inert. They are, in fact, about as safe, whether working or not, as electrical apparatus can be.

### It'll Be Welcome

THOSE who live on or near the East Anglian coast hardly know what it is nowadays to receive a B.B.C. sound programme free from interference. Direct intrusion of foreign stations, ear-splitting heterodynes and the maddening signals from radio beacons all play their horrid parts in ruining reception. Very rarely can one use one's set as a means of entertainment. Many people seldom switch on except to hear some important item of news or to get the sports results. The Norwich (Tacolneston) f.m. station is due on the air in a few months now. And won't it just be welcome!



(TO B.S. 98/E.10)

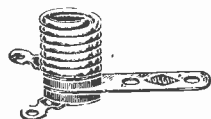

**Bulgin Pilot Lampholders** to accept Miniature Edison Screw-cap lamps are manufactured to B.S. 98/E.10 specifications and to the usual high Bulgin standards, using the finest available materials. The range is vast and further special types and finishes (such as RCS.1000) can be made to quantity orders.



**STEEL SPRING** helix-“shell” extending upon tightening the lamp; gives vibration-resisting grip. Illustration shows flat-arm bracket.



**M.S.T. HOLDER** with Cadmium-plated clip. Open-“shell” for normal M.E.S. cap lamps. Available with many other brackets and clips.



**MOULDED-BASE** Model. Moisture resisting. Heavily plated. Lamp-pip connection is by sprung-plunger with integral tag.



**ROLLED-SHELL** types. Illustration shows model without bracket, but with rubber grommet for fitting directly to chassis, etc.

**DECORATION LAMPHOLDER.** Insulated shroud of P.V.C., normally supplied black, but available in many other colours to quantity orders.



**BELL-MOUTHED** version of the model above. Normally hung in a run of wiring but may be wedged in  $\frac{1}{8}$  in. diam. hole.

★ SEND NOW FOR LATEST CATALOGUE  
REF. No. 195/WW.  
PRICE 1/- POST FREE

# BULGIN

THE CHOICE OF CRITICS



Telephone: RlPpleway 5588 (5 lines)

A. F. BULGIN & CO. LTD. · BYE-PASS ROAD · BARKING · ESSEX

# UNBIASED

By FREE GRID

## When, Whence, Whither, Who?

WE all know when wireless telegraphy was born, but I have been having great difficulty in finding out when, whence, whither and by whom the first message was sent by wireless telephony. It was obviously long after Marconi's pioneer days, as c.w. had to be invented first, and that reminds me, I don't even know the when and who of this.

The birth of radiotelephony was certainly in pre-valvular days. I don't mean before November 16th, 1904, but before the valve came into use as a generator of oscillations. I seem to recollect somebody in the early c.w. days sticking a prodigious number of parallel water-cooled microphones in series with the aerial, the paralleling being necessary so that they could handle the large power without burning out too soon. But apart from this hazy recollection I am as ignorant as old Kaspar was about the battle of Blenheim, and I hope you can do more to satisfy my thirst for knowledge than he could for little Peterkin.

## Art or Science?

THE word "art" has often been used in the editorial columns to describe wireless or electronics and I am sorry to see in the January issue that it has caused distress to one reader who wants the word banned in favour of "science." He says that the true engineer should be able to deduce by scientific reasoning why or why not a circuit is good.

Maybe he can nowadays, but I am quite certain that this was not so in the hit-and-miss days of thirty years ago. It was then a fine art to get a super-regenerative receiver to function satisfactorily and steadily, and those who could do it were few and far between. I met some of them but not one could explain how he did it any more than Rembrandt in his day could explain his skill with the brush.

A super-regenerative receiver of the early twenties was more unpredictable and capricious than a

woman. In fact a well-known psychiatrist of the period, who was also in the front rank of radio experimenters, told me that he had observed that men who could tame a "super-regen." also had a wonderful way with women. That, as you will remember, was an achievement that even excited the obvious envy of Solomon, despite all his wisdom and experience.

Nowadays, of course, the art of "super-regen." control has been developed into a science and anybody can learn how to make one of these formerly intractable receivers eat out of his hand, but the taming of women still remains an art known only to the few like Petruccio. Even this may one day become an exact science.

The truth is that all branches of science start as an art in which only the chosen few, gifted with a strange intuitive genius, are proficient. Eventually knowledge is painfully acquired and becomes available to all who care to study, and so the former art becomes a science. I regard radio as just emerging from the chrysalis state of art, but until it has fully done so it is incorrect to call it by either name.

## Wireless in the Wilds

I WONDER if any of you who live within comfortable range of one of the B.B.C. transmitters and are able to sit back and really enjoy the programmes ever spare a thought for those less fortunately situated in the wilds of Wales or Scotland—or even of England—whose listening is punctuated by fading, distortion and "noises off."

It is for these people that the B.B.C. has embarked on its v.h.f. service and it hopes—somewhat optimistically in my opinion—eventually to give "local station" reception to over 90 per cent of the population by this means. To give equal results to the remaining 10 per cent would need a very great and expensive extension of the v.h.f. service.

For a long time past I have thought that the real solution to the problems of those who find themselves left out in the listening jungle is for communities to erect their own fly-power v.h.f. station which would be linked to the B.B.C. network by a landline rented from the G.P.O. In certain cases—such as in the Western Isles—each transmitter would have its own diesel-powered generating unit.

It would be hopeless to try to erect

and operate such a station on a basis of voluntary subscription, especially in Scotland. The only real solution to the problem would be for the thing to be run by the local council along with other public services at a cost of no more than a few bawbees added to the local rates.

## Robinson Crusoe's Radio

MANY people have told us, in the old desert-island discs programme, what sort of records they would take with them if sentenced to spend a period of solitary confinement on a desert island. Nobody but myself, however, seems to have thought of what sort of wireless set they would



Desert island delights.

take in similar circumstances. Desert islands are usually situated in remote localities, but a good s.w. receiver would bring in all the music the heart could desire.

The only snag is l.t. and h.t. supply. One could take enough spare valves and components to last a lifetime, but spare dry cells would soon dry up, as desert islands seem to be always in tropical seas. Accumulators and a wind-driven generator wouldn't do as, no matter how carefully tended, the plates of the cells would eventually disintegrate in the course of a life sentence.

I would be chary of trying to store even "inert" dry cells in tropical regions. I think my solution—laugh if you will—would be a large quantity of the old-fashioned wet Leclanché cells which we used to employ for our domestic electric bells in days of yore; in some districts they are still in use. It would be easy to take a large supply of spare zinc rods or even porous pots. But there is one point on which I need the advice of you battery experts. Should I need to take sacks of spare sal-ammoniac, which is ammonium chloride, or could I use sodium chloride, or in other words sea water? The ideal source of power in such circumstances would be solar batteries but as far as I know they are not yet in production.



Both equally intractable.